

# Repair Manual

## Roller RD 12



EN

5000192242

02

0912



5 0 0 0 1 9 2 2 4 2

**Copyright notice**

© Copyright 2012 by Wacker Neuson Production Americas LLC  
All rights, including copying and distribution rights, are reserved.  
This publication may be photocopied by the original purchaser of the machine. Any other type of reproduction is prohibited without express written permission from Wacker Neuson Production Americas LLC.  
Any type of reproduction or distribution not authorized by Wacker Neuson Production Americas LLC represents an infringement of valid copyrights. Violators will be prosecuted.

---

**Trademarks**

All trademarks referenced in this manual are the property of their respective owners.

---

**Manufacturer**

Wacker Neuson Production Americas LLC  
N92W15000 Anthony Avenue  
Menomonee Falls, WI 53051 U.S.A.  
Tel: (262) 255-0500 · Fax: (262) 255-0550 · Tel: (800) 770-0957  
[www.wackerneuson.com](http://www.wackerneuson.com)

---

**Original instructions**

This Operator's Manual presents the original instructions. The original language of this Operator's Manual is American English.

---

This manual covers machines with Item Number:  
**0620058, 0620320, 0620369, 0620059, 0620321**

### **Operating / Parts Information**

You must be familiar with the operation of this machine before you attempt to troubleshoot or repair it. Basic operating and maintenance procedures are described in the Operator's Manual supplied with the machine. Keep a copy of the Operator's Manual with the machine at all times. Use the separate Parts Book supplied with the machine to order replacement parts. If you are missing either of the documents, please contact Wacker Neuson Corporation to order a replacement.

Damage caused by misuse or neglect of the unit should be brought to the attention of the operator to prevent similar occurrences from happening in the future.

This manual provides information and procedures to safely repair and maintain the above Wacker Neuson model(s). For your own safety and protection from injury, carefully read, understand, and observe all instructions described in this manual. THE INFORMATION CONTAINED IN THIS MANUAL IS BASED ON MACHINES MANUFACTURED UP TO THE TIME OF PUBLICATION. WACKER NEUSON CORPORATION RESERVES THE RIGHT TO CHANGE ANY PORTION OF THIS INFORMATION WITHOUT NOTICE.

**CALIFORNIA****Proposition 65 Warning:**

Engine exhaust, some of its constituents, and certain vehicle components, contain or emit chemicals known to the State of California to cause cancer and birth defects or other reproductive harm.

All rights, especially copying and distribution rights, are reserved.

Copyright 2009 by Wacker Neuson Corporation

No part of this publication may be reproduced in any form or by any means, electronic or mechanical, including photocopying, without express written permission from Wacker Neuson Corporation.

Any type of reproduction or distribution not authorized by Wacker Neuson Corporation represents an infringement of valid copyrights, and violators will be prosecuted. We expressly reserve the right to make technical modifications, even without due notice, which aim at improving our machines or their safety standards.

<b>1</b>	<b>Safety Information</b>	<b>9</b>
1.1	Operating Safety .....	10
1.2	Operator Safety while using Internal Combustion Engines .....	12
1.3	Service Safety .....	13
1.4	Label Locations .....	15
1.5	Safety and Operating Labels .....	16
<b>2</b>	<b>Operation</b>	<b>22</b>
2.1	Operation and Service Locations .....	22
2.2	Control Panel .....	24
2.3	Vibration .....	26
2.4	Water Spray System .....	27
2.5	Starting .....	28
2.6	Stopping/Parking .....	30
2.7	Auxiliary Battery Positive Terminal .....	31
<b>3</b>	<b>Honda Engine Starting System</b>	<b>32</b>
3.1	Checking the 20A Main Fuse .....	33
3.2	Checking Wiring to the Starter Solenoid & Anti-backfire Solenoid .....	34
3.3	Checking the Key Switch .....	36
3.4	Checking the Crank Relay .....	37
3.5	Checking the Neutral Switch .....	38
3.6	Checking the Neutral Relay .....	39
<b>4</b>	<b>Wacker Neuson Engine Starting System</b>	<b>40</b>
4.1	Checking the 20A Main Fuse .....	41
4.2	Checking the Wiring to the Starter Solenoid & Anti-backfire Solenoid .....	42
4.3	Checking the Key Switch .....	43
4.4	Checking the Crank Relay .....	44
4.5	Checking the Neutral Switch .....	45
4.6	Checking the Neutral Relay .....	46

<b>5</b>	<b>Drive System</b>	<b>48</b>
5.1	Checking the Tow Valve .....	49
5.2	Adjusting the Drive Control Cable .....	50
5.3	Checking the Drive System Operating Pressure .....	51
5.4	Checking the Drive System Relief Pressure .....	52
5.5	Checking Drive Motors for Binding .....	53
5.6	Checking Oil Flow through the Drive Motors .....	55
<b>6</b>	<b>Vibration System and Steering</b>	<b>56</b>
6.1	Checking the Engine Speed and Vibration Speed .....	57
6.2	Troubleshooting a System that Vibrates Poorly .....	58
6.3	Checking the Vibration Solenoid Valve .....	60
6.4	Checking the Vibration Switch .....	61
<b>7</b>	<b>Steering System</b>	<b>62</b>
7.1	Checking the Steering System Hydraulic Pressure .....	62
7.2	Troubleshooting the Steering System .....	63
<b>8</b>	<b>Spray System</b>	<b>64</b>
8.1	Troubleshooting the Spray System .....	64
8.2	Checking Power to the Spray Bar Pump .....	65
8.3	Checking the Pump Timer Module .....	66
8.4	Checking the Spray System Switch .....	67
<b>9</b>	<b>Disassembly &amp; Assembly</b>	<b>68</b>
9.1	Tools Required for Disassembly/Assembly Procedures .....	68
9.2	Information Regarding Replacement Parts .....	68
9.3	Information Regarding Reference Numbers ( ) .....	68
9.4	Information Regarding Threadlocking Compounds .....	68
9.5	Removing the Articulating Joint .....	69
9.6	Installing the Articulating Joint .....	70

9.7	Removing the Rear Drum .....	71
9.8	Installing the Rear Drum .....	73
9.9	Removing the Brake and Brake Cable .....	75
9.10	Installing the Brake and Brake Cable .....	77
9.11	Removing Rear Drive Motor .....	79
9.12	Installing the Rear Drive Motor .....	81
9.13	Removing the Front Drum .....	83
9.14	Installing the Front Drum .....	85
9.15	Removing the Front Drive Motor .....	87
9.16	Installing the Front Drive Motor .....	88
9.17	Removing the Exciter .....	89
9.18	Installing the Exciter .....	91
9.19	Disassembling the Exciter Bearings .....	93
9.20	Assembling the Exciter Bearings .....	95
9.21	Removing the Control Cable and Control Lever .....	97
9.22	Installing the Control Cable and Control Lever .....	99
9.23	Removing the Exciter Pump .....	100
9.24	Installing the Exciter Pump .....	101
9.25	Removing the Drive Pump .....	102
9.26	Installing the Drive Pump .....	103
9.27	Removing the Engine .....	104
9.28	Installing the Engine .....	106
9.29	Removing the Steering Valve .....	108
9.30	Installing the Steering Valve .....	110
9.31	Removing the Hydraulic Tank .....	112
9.32	Installing the Hydraulic Tank .....	114
9.33	Removing the Fuel Tank .....	116
9.34	Installing the Fuel Tank .....	118

## 10 Schematics 120

10.1	Hydraulic Schematic .....	120
10.2	Hydraulic Schematic Components .....	121
10.3	Electrical Schematic Identification—RD 12A .....	121
10.4	Electrical Schematic “A”—RD 12A .....	122
10.5	Electrical Schematic “A” Components—RD 12A .....	123
10.6	Electrical Schematic “B”—RD 12A .....	124
10.7	Electrical Schematic “B” Components—RD 12A .....	125
10.8	Electrical Schematic—RD 12 .....	126
10.9	Electrical Schematic Components—RD 12 .....	127

<b>11</b>	<b>Technical Data</b>	<b>128</b>
11.1	Engine .....	128
11.2	Roller .....	129
11.3	Lubrication .....	129
11.4	Dimensions .....	130
11.5	Sound Measurements .....	131
11.6	Measurements of Operator Exposure to Vibration .....	131
11.7	Hydraulic Pressures .....	132



## 1 Safety Information

This manual contains DANGER, WARNING, CAUTION, *NOTICE* and NOTE callouts which must be followed to reduce the possibility of personal injury, damage to the equipment, or improper service.



This is the safety alert symbol. It is used to alert you to potential personal injury hazards. Obey all safety messages that follow this symbol to avoid possible injury or death.



**DANGER**

DANGER indicates a hazardous situation which, if not avoided, will result in death or serious injury.



**WARNING**

WARNING indicates a hazardous situation which, if not avoided, could result in death or serious injury.



**CAUTION**

CAUTION indicates a hazardous situation which, if not avoided, could result in minor or moderate injury.

**NOTICE:** Used without the safety alert symbol, **NOTICE** indicates a situation which, if not avoided, could result in property damage.

**Note:** *Contains additional information important to a procedure.*

## 1.1 Operating Safety

**Notice:** State Health Safety Codes and Public Resources Codes specify that in certain locations spark arresters be used on internal combustion engines that use hydrocarbon fuels. A spark arrester is a device designed to prevent accidental discharge of sparks or flames from the engine exhaust. Spark arresters are qualified and rated by the United States Forest Service for this purpose.

In order to comply with local laws regarding spark arresters, consult the engine distributor or the local Health and Safety Administrator.



Familiarity and proper training are required for the safe operation of the machine. Machines operated improperly or by untrained personnel can be hazardous. Read the operating instructions contained in this manual and the engine manual, and familiarize yourself with the location and proper use of all controls. Inexperienced operators should receive instruction from someone familiar with the machine before being allowed to operate it.

- 1.1.1 DO NOT drive over curbs or other uneven objects that will result in the machine and operator being shaken.
- 1.1.2 DO NOT attempt to start the machine when standing alongside it. Only start the engine when seated in the driver's seat and with the forward/reverse control in the neutral position.
- 1.1.3 Do not allow anyone to operate this equipment without proper training. People operating this equipment must be familiar with the risks and hazards associated with it.
- 1.1.4 Do not touch the engine or muffler while the engine is on or immediately after it has been turned off. These areas get hot and may cause burns.
- 1.1.5 Do not use accessories or attachments that are not recommended by Wacker Neuson. Damage to equipment and injury to the user may result.
- 1.1.6 NEVER leave the machine running unattended.
- 1.1.7 NEVER operate the machine with the fuel cap loose or missing.
- 1.1.8 NEVER carry passengers on the machine. Danger of crushing—keep clear of the articulated steering joint between the front and rear frames.
- 1.1.9 NEVER use or attempt to repair damaged safety belts or ROPS. Replace only with Wacker Neuson spare parts.
- 1.1.10 ALWAYS disengage and stow the locking bar for the articulated steering joint before operating the machine. The machine cannot be steered when the locking bar is engaged.
- 1.1.11 ALWAYS check that all controls are functioning properly immediately after start-up! DO NOT operate the machine unless all controls operate correctly.

- 1.1.12 ALWAYS remain aware of changing positions and the movement of other equipment and personnel on the job site.
- 1.1.13 ALWAYS remain seated and wear the seat belt at all times while operating the machine.
- 1.1.14 ALWAYS remain aware of changing surface conditions and use extra care when operating over uneven ground, on hills, or over soft or coarse material. The machine could shift or slide unexpectedly.
- 1.1.15 ALWAYS use caution when operating the machine near the edges of pits, trenches or platforms. Check to be sure that ground surface is stable enough to support the weight of the machine with operator and that there is no danger of the roller sliding, falling or tipping.
- 1.1.16 ALWAYS wear protective clothing appropriate to the job site when operating the machine.
- 1.1.17 ALWAYS keep hands, feet, and loose clothing away from moving parts of the machine.
- 1.1.18 Read, understand, and follow procedures in the Operator's Manual before attempting to operate the machine.
- 1.1.19 Store the machine properly when it is not being used. The machine should be stored in a clean, dry location out of the reach of children.
- 1.1.20 Always operate the machine with all safety devices and guards in place and in working order.
- 1.1.21 ALWAYS be sure that all other persons are at a safe distance from the machine. Stop the machine if people step into the working area of the machine.

## 1.2 Operator Safety while using Internal Combustion Engines

**WARNING**

Internal combustion engines present special hazards during operation and fueling. Read and follow the warning instructions in the engine owner's manual and the safety guidelines below. Failure to follow the warnings and safety standards could result in severe injury or death.

- 1.2.1 Do not smoke while operating the machine.
- 1.2.2 Do not smoke when refueling the engine.
- 1.2.3 Do not refuel a hot or running engine.
- 1.2.4 Do not refuel the engine near an open flame.
- 1.2.5 Do not spill fuel when refueling the engine.
- 1.2.6 Do not run the engine near open flames.
- 1.2.7 Do not run the machine indoors or in an enclosed area such as a deep trench unless adequate ventilation, through such items as exhaust fans or hoses, is provided. Engine exhaust contains carbon monoxide. This is a poison you cannot see or smell. Exposure to carbon monoxide can cause loss of consciousness and CAN KILL YOU IN MINUTES.
- 1.2.8 Refill the fuel tank in a well-ventilated area.
- 1.2.9 Replace the fuel tank cap after refueling.
- 1.2.10 ALWAYS keep the area around a hot exhaust pipe free of debris to reduce the chance of an accidental fire.
- 1.2.11 ALWAYS check the fuel lines and the fuel tank for leaks and cracks before starting the engine. Do not run the machine if fuel leaks are present or the fuel lines are loose.

### 1.3 Service Safety



A poorly maintained machine can become a safety hazard! In order for the machine to operate safely and properly over a long period of time, periodic maintenance and occasional repairs are necessary.

- 1.3.1 Some service procedures require that the machine's battery be disconnected. To reduce the risk of personal injury, read and understand the service procedures before performing any service to the machine.
- 1.3.2 All adjustments and repairs **MUST** be completed before operation. Do not operate the machine with a known problem or deficiency! All repairs and adjustments should be completed by a qualified technician.
- 1.3.3 Do not attempt to clean or service the machine while it is running. Rotating parts can cause severe injury.
- 1.3.4 Do not crank a flooded engine with the spark plug removed on gasoline-powered engines. Fuel trapped in the cylinder will squirt out the spark plug opening.
- 1.3.5 Do not test for spark on gasoline-powered engines if the engine is flooded or the smell of gasoline is present. A stray spark could ignite the fumes.
- 1.3.6 Do not use gasoline or other types of fuels or flammable solvents to clean parts, especially in enclosed areas. Fumes from fuels and solvents can become explosive.
- 1.3.7 Do not modify the machine without the express written approval of the manufacturer.
- 1.3.8 **DO NOT** stand under the machine while it is being hoisted or moved.
- 1.3.9 **DO NOT** get onto the machine while it is being hoisted or moved.
- 1.3.10 **DO NOT** use the machine as a ladder. Use safe ladders and platforms designed for this purpose.
- 1.3.11 **DO NOT** modify, weld, or drill safety frames (ROPS) fitted as original equipment. **DO NOT** loosen or remove bolts. **DO NOT** weld, drill or modify a broken safety frame.
- 1.3.12 **DO NOT** open the hydraulic lines or loosen the hydraulic connections while the engine is running! Before dismantling the hydraulic connectors or hoses, ensure that all pressure has been bled from the circuit. Hydraulic fluid under pressure can penetrate the skin, cause burns, blind, or create other personal injury hazards. Set all controls in neutral, turn engine off, and allow the fluids to cool before loosening hydraulic fittings or attaching test gauges.
- 1.3.13 **ALWAYS** check all external fasteners at regular intervals.

- 1.3.14 Keep the area around the muffler free of debris such as leaves, paper, cartons, etc. A hot muffler could ignite the debris and start a fire.
- 1.3.15 Replace worn or damaged components with spare parts designed and recommended by Wacker Neuson Corporation.
- 1.3.16 Disconnect the spark plug on machines equipped with gasoline engines, before servicing, to avoid accidental start-up.
- 1.3.17 Keep the machine clean and labels legible. Replace all missing and hard-to-read labels. Labels provide important operating instructions and warn of dangers and hazards.
- 1.3.18 ALWAYS do periodic maintenance as recommended in the Operator's Manual.
- 1.3.19 ALWAYS turn the engine off before performing maintenance or making repairs.
- 1.3.20 ALWAYS keep hands, feet and loose clothing away from moving parts.
- 1.3.21 ALWAYS make sure slings, chains, hooks, ramps, jacks and other types of lifting devices are attached securely and have enough weight-bearing capacity to lift or hold the machine safely. Always remain aware of the location of other people in the area when lifting the machine.
- 1.3.22 ALWAYS make sure hose connections have been reconnected back to the correct fitting. Failure to do so may result in damage to the machine and/or injury to person on or near the machine.
- 1.3.23 ALWAYS secure the articulated steering joint using the locking bar before lifting, jacking, and servicing the machine. The machine halves could swing together unexpectedly and cause a serious injury.
- 1.3.24 ALWAYS lock the lifting cylinders in the open position when the seat pedestal is raised.
- 1.3.25 Before you start the machine, ensure that all tools have been removed from the machine and that replacement parts and adjusters are firmly tightened.
- 1.3.26 Fluid leaks from small holes are often practically invisible. DO NOT use your bare hands to check for leaks. Check for leaks using a piece of cardboard or wood.

1.4 Label Locations

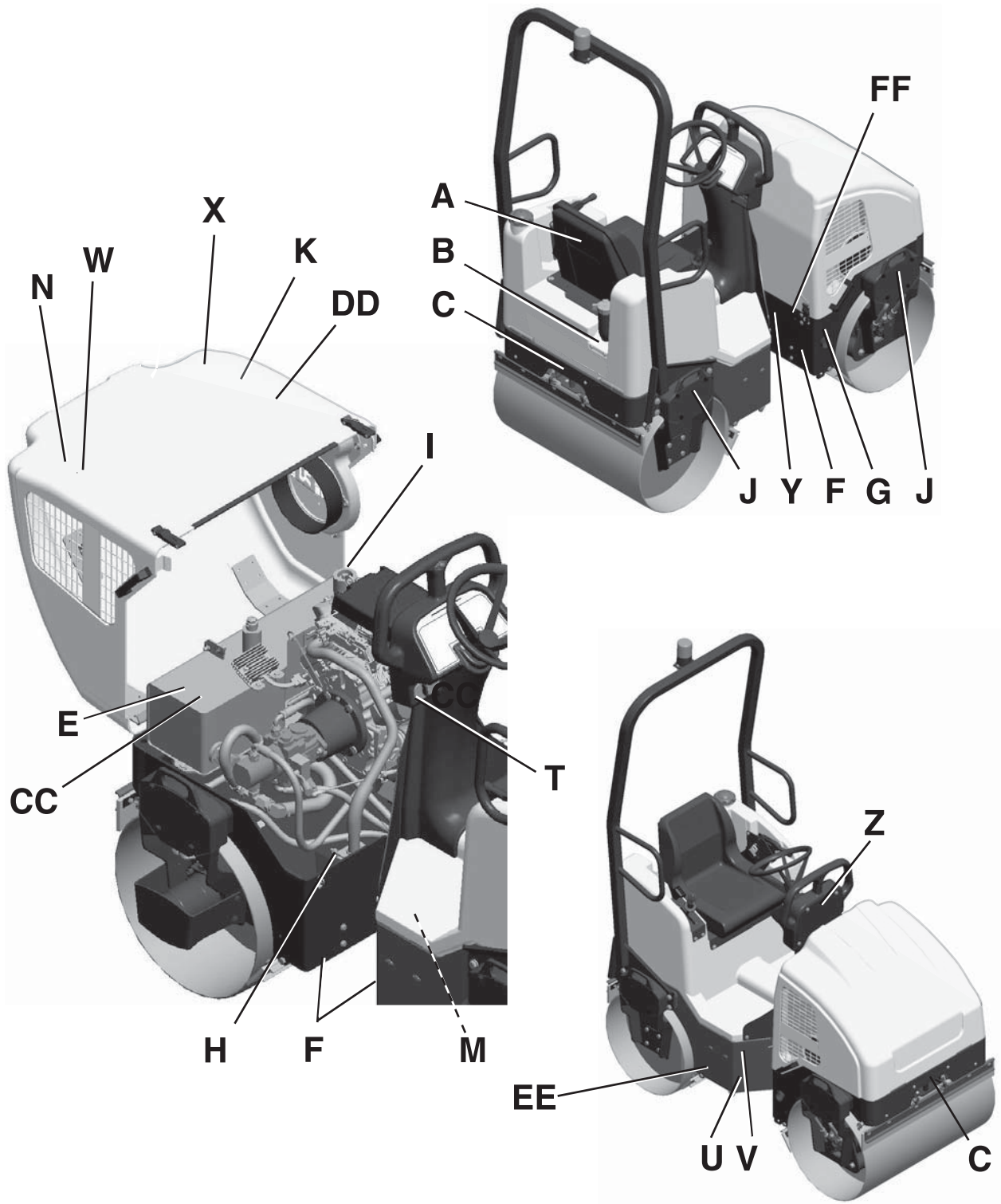



wc\_gr002988





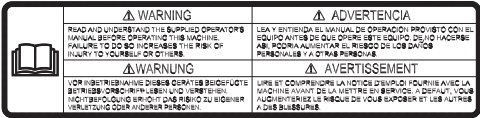
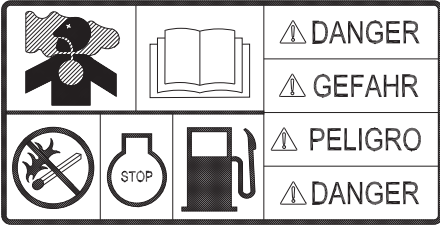
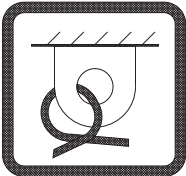
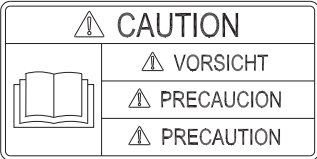





1.5 Safety and Operating Labels

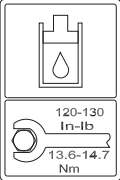

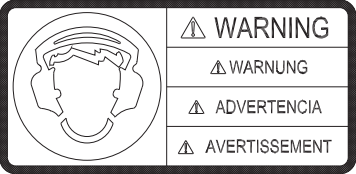

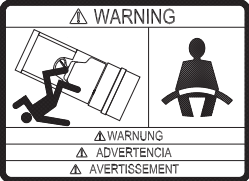
Wacker Neuson machines use international pictorial labels where needed. These labels are described below:

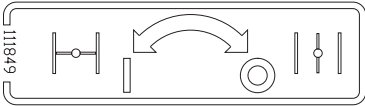
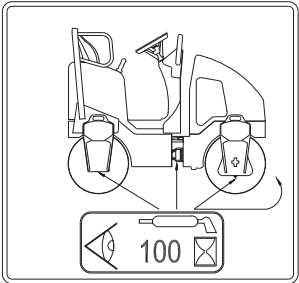
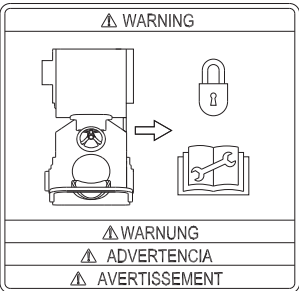
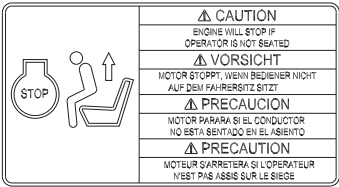
Ref.	Label	Meaning
A		<p><b>WARNING!</b> Read and understand the supplied Operator's Manual before operating the machine. Failure to do so increases the risk of injury to yourself or others.</p>
B	 <p>117034</p>	<p><b>DANGER!</b> Engines emit carbon monoxide; operate only in well-ventilated area. Read the Operator's Manual. No sparks, flames, or burning objects near the machine. Shut off the engine before refueling.</p>
C		<p>Tie-down point</p>
E		<p><b>CAUTION!</b> Read and understand the supplied Operator's Manual before operating this machine. Failure to do so increases the risk of injury to yourself or others.</p>
F	 <p>110176</p>	<p><b>WARNING!</b> Pinch point.</p>

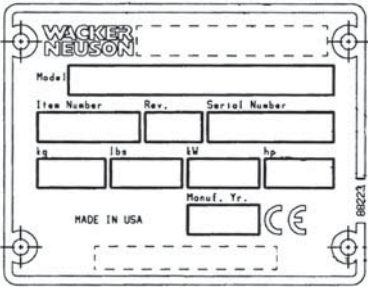
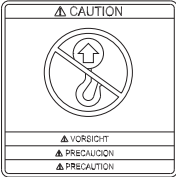

Ref.	Label	Meaning
G		WARNING! Hot surface!
H		WARNING! Hot surface!
I		Hydraulic oil reservoir fill tube. Torque nuts to 13.6-14.7 Nm (120-130 in.lbs.) maximum.
J		CAUTION Lifting point.
K		WARNING! To prevent hearing loss, wear hearing protection when operating this machine.
M		WARNING! Disconnect battery before servicing. Read Repair Manual for instructions. Battery contains caustic acid and potentially explosive hydrogen gas.
N		WARNING! Always wear seat belt when operating roller.

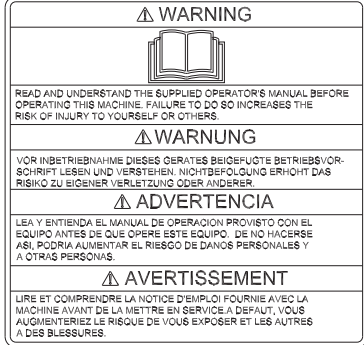
Ref.	Label	Meaning
T		<p>Choke: 0 = Open</p> <p>I = Closed</p>
U		<p>Grease points: Inspect and lubricate every 100 hours of operation.</p>
V		<p><b>WARNING!</b></p> <p>Avoid crushing area. Articulated steering joint locking location. Lock the articulated steering joint before servicing the machine. Read Repair Manual.</p>
W		<p>Engine will stop without operator seated.</p>
X		<p>Guaranteed sound power level in dB(A).</p>

Ref.	Label	Meaning
Y		<p>A nameplate listing the model number, item number, revision number, and serial number is attached to each unit. Please record the information found on this plate so it will be available should the nameplate become lost or damaged. When ordering parts or requesting service information, you will always be asked to specify the model number, item number, revision number, and serial number of the unit.</p>
Z		<p>No lift point.</p>
CC		<p>CAUTION! Electric shock hazard at auxiliary battery positive terminal. Never touch this terminal and a metal portion of the machine simultaneously.</p>
DD		<p>WARNING! Read and understand the supplied Operator's Manual before operating the machine. Failure to do so increases the risk of injury to yourself or others.</p>
EE		<p>Water tank</p>

Ref.	Label	Meaning
FF	 <p>U.S.PAT.Nos.: 5082396, 5450068, 5564375, 5586630, 5984425, 6285925, 6382383, D396727, D454141, D461197 OTHER U.S. AND FOREIGN PATENTS PENDING ROLLER 159114</p>	<p>This machine may be covered by one or more patents.</p>

**Notes**

**2 Operation**

**2.1 Operation and Service Locations**

*See Graphic: wc\_gr002946*

<b>Ref.</b>	<b>Description</b>	<b>Ref.</b>	<b>Description</b>
1	Air cleaner	24	Operator's platform
2	Articulated joint	25	Engine oil filter
3	Hand holds	26	Rear drum fill/drain plug
4	Control panel	27	Rear drum—static
5	Dipstick	28	Scraper bar (4 places)
6	Drain hose—hydraulic tank	29	Sightglass—hydraulic tank
7	Drive motor	30	Sprinkler tube (2)
8	Drive pump	31	Steering wheel
9	Engine hood	32	Steering cylinder (under floor panel)
10	Vibration control button	33	Tiedown (2 places)
11	Exciter motor	34	Beacon light (optional)
12	Exciter/Steering pump	35	Battery (under floor panel)
13	Hydraulic filter—return line	36	Hydraulic suction line
14	Hydraulic strainer—suction line	37	Grease fitting—exciter (2 places)
15	Forward / Reverse control	38	Lifting eye (4 places)
16	Front drum—vibratory	39	ROPS
17	Fuel tank fill cap	40	Seat with seatbelt
18	Fuel filter	41	Water drain
19	Grease fittings—articulated joint (4 places)	42	Parking brake
20	Hydraulic tank fill port	43	Tow valve
21	Hydraulic manifold block	44	Choke lever
22	Water tank fill cap	45	Auxiliary battery positive terminal
23	Lockarm	-	---

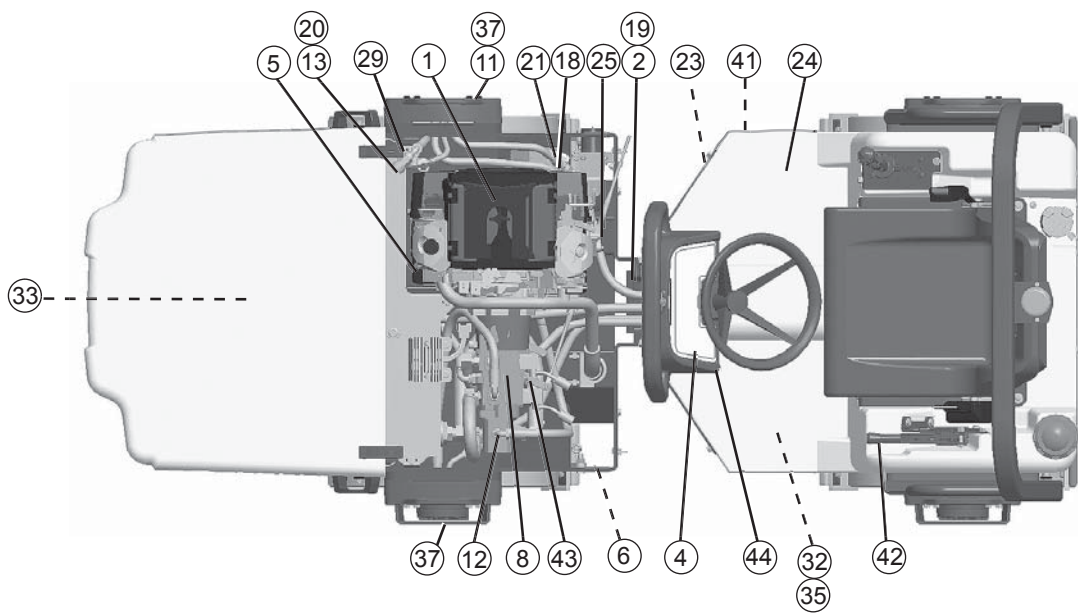
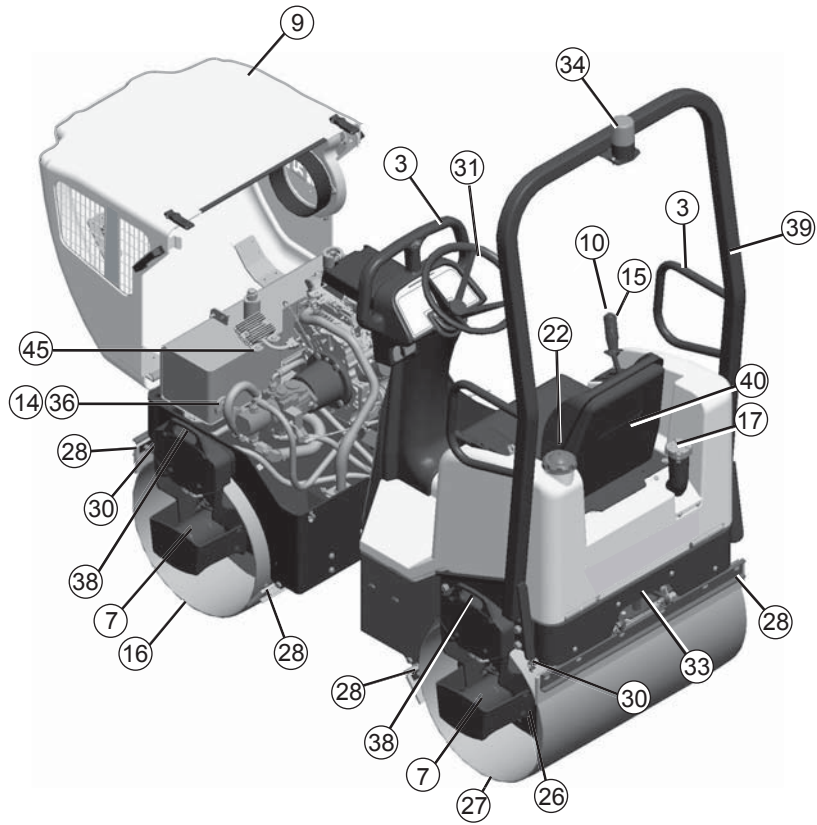

wc\_gr002946

**2.2 Control Panel**

*See Graphic: wc\_gr004114*

<b>Ref.</b>	<b>Description</b>	<b>Ref.</b>	<b>Description</b>
47	Hour meter	55	Ignition switch
50	Vibration ON indicator	56	Low fuel indicator
53	Lights switch - ON and OFF (if equipped)	61	Water spray switch - ON and OFF
54	Throttle switch - HIGH and LOW	62	Water spray dial



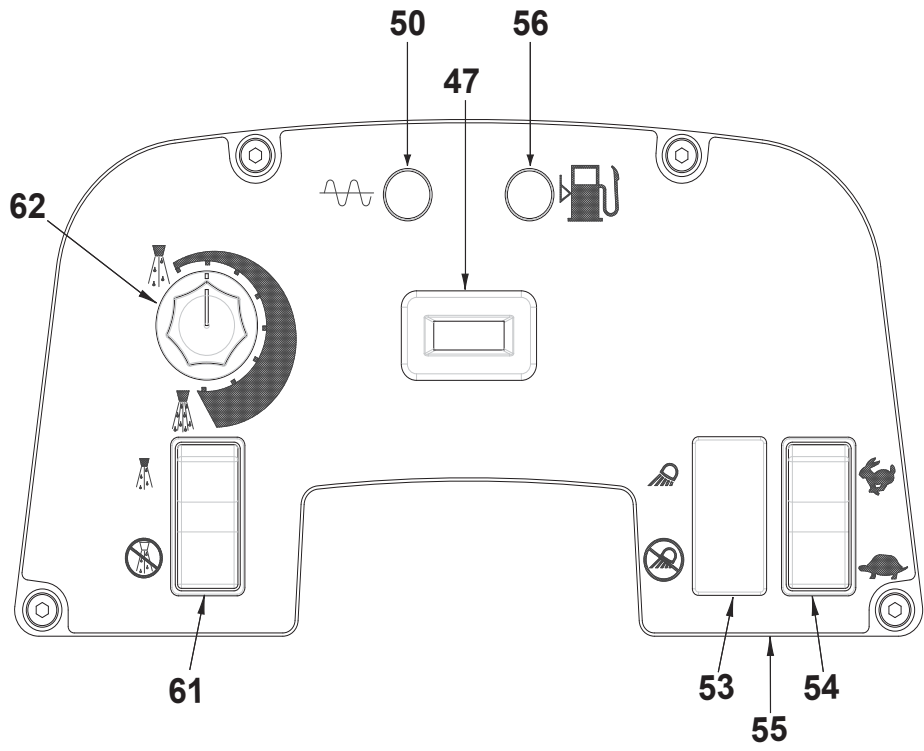

wc\_gr004114

## 2.3 Vibration

See Graphic: wc\_gr002955

The vibration is turned ON or OFF by a push button (10) located on the forward/reverse control (15). Press the button to turn vibration ON; press it again to turn it OFF. The vibration ON indicator (50) will light when vibration is on. The vibration can be turned on while operating in either forward or reverse and will remain on until it is turned off.

On the RD 16, select either the front drum vibration or dual drum vibration by pressing the vibration switch (63) on the control panel.

**CAUTION:** If the machine has been turned off with the vibration on, the vibration will come on as soon as the machine is restarted. Therefore, for easier starting and to keep the surface finish smooth, be ready to switch vibration off should it come on while cranking the engine.

**Note:** The vibration will remain on even when the forward/reverse control (15) is in NEUTRAL. When operating on asphalt and in order to keep the surface finish smooth, turn the vibration off before stopping the roller.

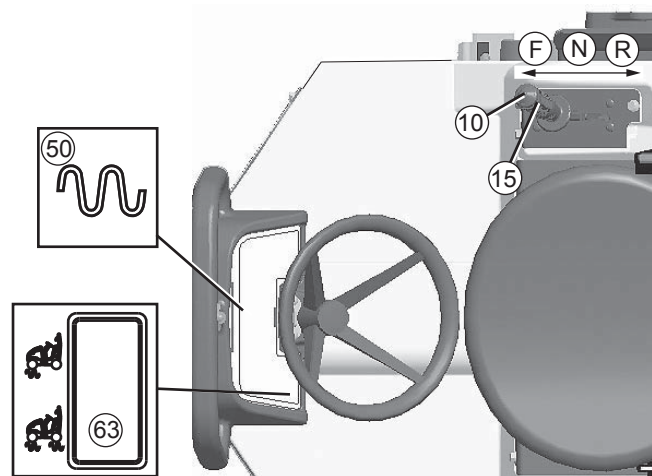

wc\_gr002955

## 2.4 Water Spray System

See Graphic: *wc\_gr002946, wc\_gr003638*

Water from the tank is fed to the spray bars by an electric pump. The flow of the water is controlled by a switch and a rotary dial.

Press the upper half of the water spray switch **(61)** to turn the water pump on. Turn the water spray dial **(62)** clockwise to increase the spray frequency. Turn the water spray dial counter-clockwise to decrease the spray frequency. Press the lower half of the water spray switch **(61)** to turn the water pump off.

Only use clean water. Dirty water, even when filtered, will rapidly clog the tubes of the spraying equipment.

During winter, or when temperatures drop to below 0°C (32°F), drain the water tank and spraying equipment. Run the water pump to remove excess water from the system. Drain the water through the water drain plug **(41)** located near the bottom of the rear frame, through the sprayer end plugs, and the water filter. Freezing water may cause broken hoses, filters and water pumps and may deform the water tank.

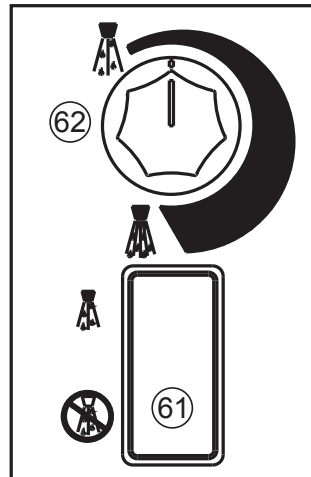

wc\_gr003638

## 2.5 Starting

See Graphic: wc\_gr002951



### WARNING

Exhaust gases are toxic. Do not start the engine in an enclosed space.

- 2.5.1 Sit down in the operator's seat and fasten the seat belt.
- 2.5.2 Set the forward/reverse control **(15)** in the neutral position.
- 2.5.3 If the engine is cold, move the choke lever **(44)** to the left into the CLOSED position. If the engine is warm, move the choke control to the right in the OPEN position.

**Note:** *The roller will not start unless the forward/reverse control is in the NEUTRAL position.*

- 2.5.4 Check that the parking brake **(42)** is set. To set the brake, pull the brake lever up until the brake pad engages the drum. To release the brake lever, lower the lever. Always set the parking brake before leaving the machine.
- 2.5.5 Turn the ignition switch **(55)** to start the engine. If the vibration indicator light **(50)** is on, turn the vibration off by pressing the vibration control button **(10)**.

**NOTICE:** Do not crank the engine starter for more than 15 seconds at one time. Longer cranking cycles could lead to starter damage.

**Note:** *The ignition switch has an anti-restart feature. If the engine does not start, the switch will need to be turned to the OFF position before it will allow the engine to be cranked again.*

- 2.5.6 Gradually place the choke lever in the OPEN position as the engine warms up. Allow the engine to warm up for a few minutes before operating the roller.
- 2.5.7 Before moving the machine, release the parking brake by lowering the brake lever.
- 2.5.8 Quickly press and release the upper half of the throttle switch **(54)** to bring the engine to high throttle.



### WARNING

Prolonged exposure to high noise levels can damage your hearing. Wear appropriate hearing protection while operating the roller.

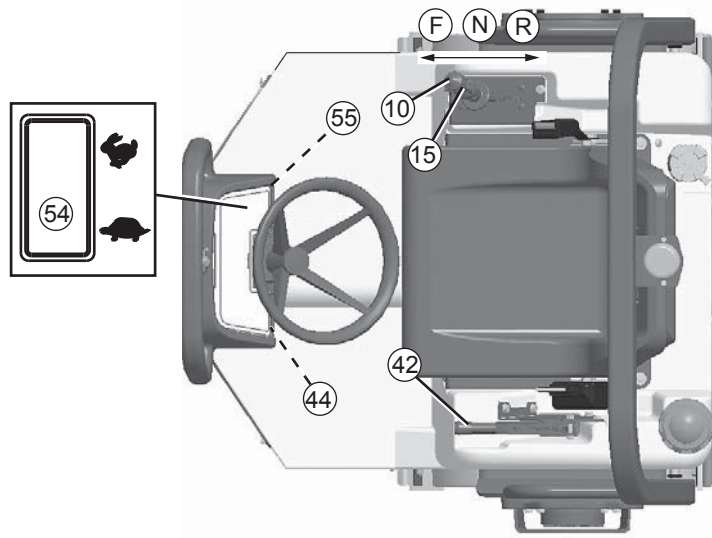

wc\_gr002951

2.6 Stopping/Parking

See Graphic: wc\_gr002953

- 2.6.1 Stop the machine on a flat surface with a suitable load bearing capacity.
  - 2.6.2 Turn the vibration off by pressing the vibration control button (10) on the forward/reverse lever (15).
  - 2.6.3 Press the water spray switch to the OFF position (61).
  - 2.6.4 Set the forward/reverse control (15) to the NEUTRAL position.
  - 2.6.5 Return the engine throttle to idle by pressing the lower half of the throttle switch (54) and allow the engine to cool down.
  - 2.6.6 Set the parking brake (42). To set the parking brake, pull the brake lever up until the brake pad engages the drum. To release the brake, lower the brake lever. Always set the parking brake before leaving the machine.
- Note:** *The parking brake engages the rear drum only.*
- 2.6.7 Stop the engine by turning the ignition switch (55) to the OFF position.



If the vehicle constitutes a hazard or obstacle to traffic when parked, it should be marked with signs, lights, and other warnings.

If the machine must be parked on a sloping surface, chock the drums with wedges to prevent any vehicle movement.

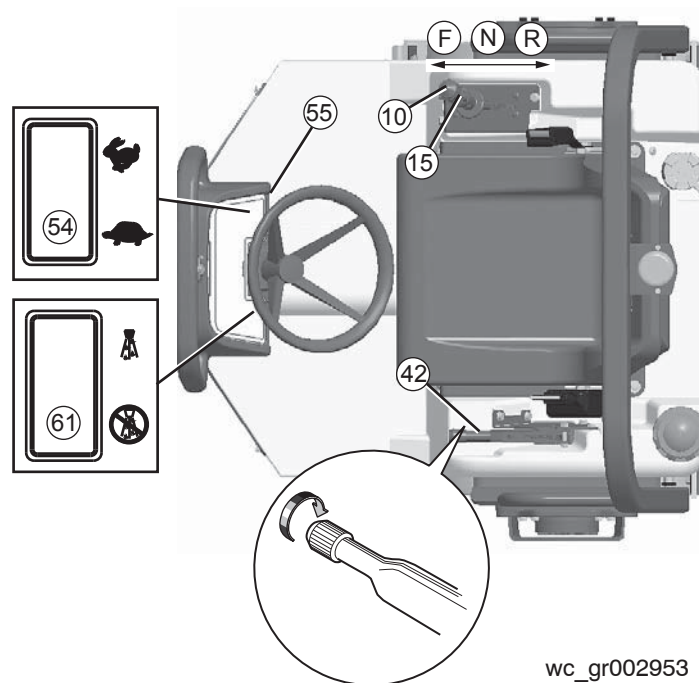

## 2.7 Auxiliary Battery Positive Terminal

This machine is equipped with an auxiliary battery positive terminal **(45)** located on top of the hydraulic tank (RD 12) or above the battery disconnect stud (RD 16).



CAUTION! Electric shock hazard. Never touch this terminal and a metal portion of the machine simultaneously.



wc\_gr004357

## 3 Honda Engine Starting System

- Prerequisites**
- Before troubleshooting engine starting issues, check the battery and the cable connections to the battery. The battery must be fully charged (approximately 12V).
- 

**Sequence** Complete the troubleshooting in the following sequence:

1. Check the 20A main fuse.
2. Check the wiring to the starter solenoid and to the anti-backfire solenoid.
3. Check the key switch.
4. Check the crank relay.
5. Check the neutral switch.
6. Check the neutral relay.



### 3.1 Checking the 20A Main Fuse

**Prerequisites** ■ Key switch in OFF position.

**Background** There are three 20A fuses protecting the circuits in the RD 12:

- Main electricals
- Voltage regulator circuit
- Optional light circuit

**Procedure** Follow the procedure below to check the 20A main fuse.

1. Open the hood and locate the fuse carrier **(a)**.

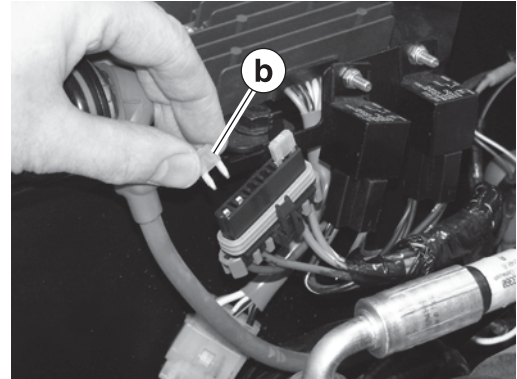
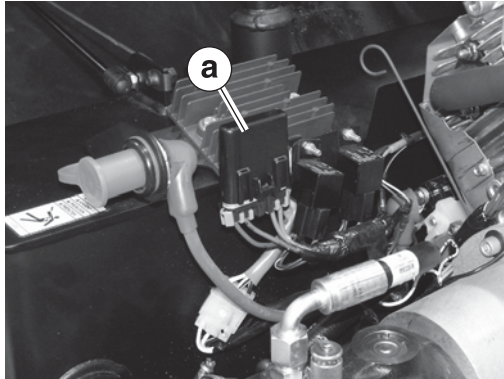

wc\_gr003914

2. Remove the protective cover from the fuse carrier.
3. Check the condition of the 20A main fuse **(b)**.

*Is the 20A fuse OK?*

**Yes** \_\_\_\_

Continue

**No** \_\_\_\_

Replace the 20A main fuse with one of same size and rating.

4. Re-install the 20A main fuse and the protective cover to the fuse carrier.

The 20A main fuse has now been checked.

## 3.2 Checking Wiring to the Starter Solenoid & Anti-backfire Solenoid

**Prerequisites** ■ Fully-charged (approximately 12V) battery

**Background** Black wire #20 delivers 12VDC to the starter solenoid when the key is in the START position. If this wire is broken or disconnected, the engine will not crank. The black/yellow wire delivers 12VDC to the anti-backfire solenoid when the key is in the ON or START positions. If this wire is broken or disconnected, the engine will not start.

**Procedure** Follow the procedure below to check the wiring to the starter solenoid and to the anti-backfire solenoid.

1. Open the hood and locate the starter/starter solenoid (a).

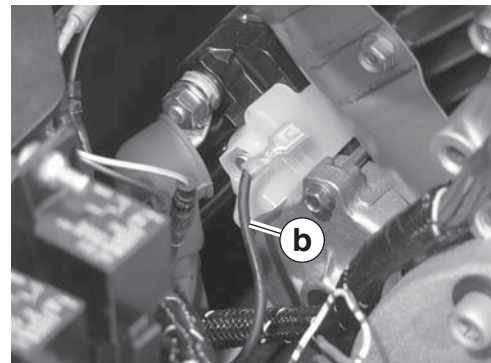
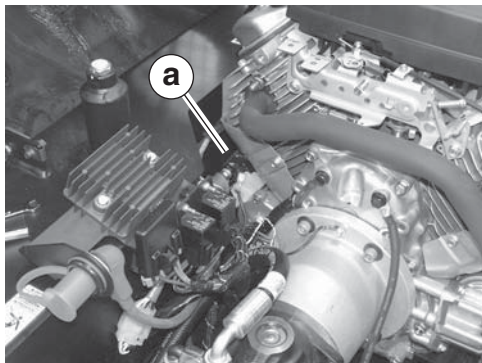

wc\_gr003920

2. Check the condition/connection of black wire #20 (b) to the starter solenoid.  
*Is the wiring OK?*

<b>Yes</b> ____	<b>No</b> ____
Continue	Reconnect or repair black wire #20.

3. Check the condition/connection of the black/yellow wire to the anti-backfire solenoid.

*Is the wiring OK?*

<b>Yes</b> ____	<b>No</b> ____
The wiring is OK.	Reconnect or repair black/yellow wire.

*This procedure continues on the next page.*

*Continued from the previous page.*

4. If the engine still won't start but cranks, remove the anti-backfire solenoid (c) and clean the valve portion of it with carburetor cleaner. Re-install it and try to start the engine.

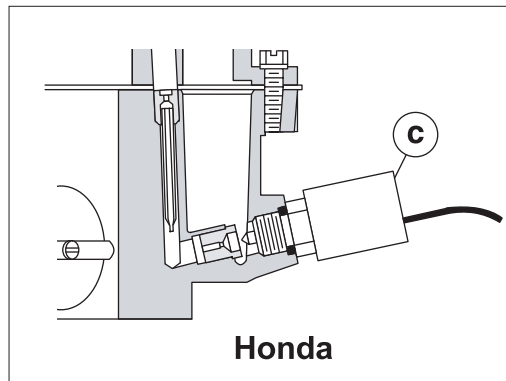

wc\_gr005343

The wiring to the starter solenoid and anti-backfire solenoid has now been checked.

## 3.3 Checking the Key Switch

- Prerequisites**
- Multimeter
  - Fully-charged (approximately 12V) battery
  - Functioning 20A main fuse

**Background** The key switch is a three-position switch: ON, START, and OFF. When in the START position, the key switch directs battery voltage to the crank relay.

**Procedure** Follow the procedure below to check the key switch.

1. Remove the screws that secure the plate (a) to the back of the control panel and remove the plate.

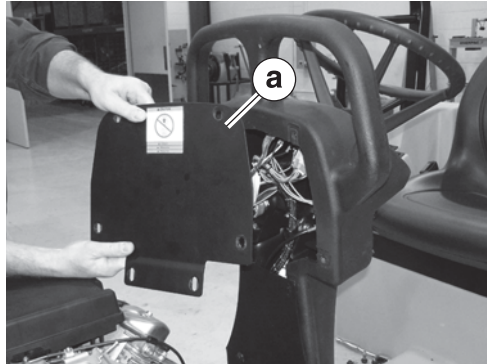

wc\_gr004201

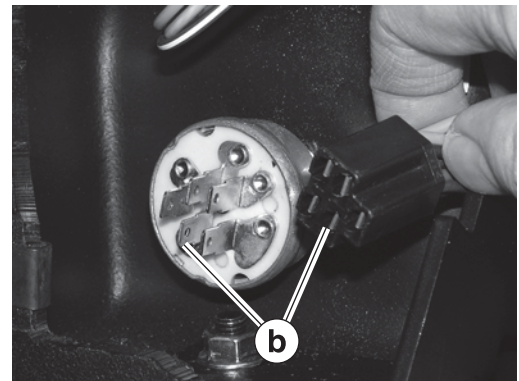

wc\_gr003915

2. Using the multimeter, check the voltage between the BAT terminal (b) of the key switch and ground. For easier measuring, remove the plug and measure voltage at the plug.

*Is battery voltage (approximately 12V) measured?*

<b>Yes</b> ____ Continue	<b>No</b> ____ Check the continuity of red wire #13 between the key switch and 20A main fuse. Repair red wire #13 as needed.
-----------------------------	---

3. Place the key switch in the START position.
4. Re-install the plug to the key switch.

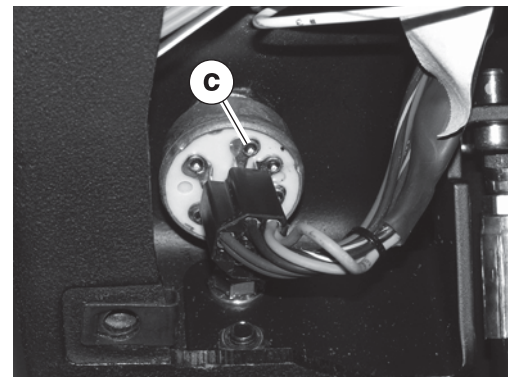

wc\_gr003916

5. Check the voltage between the "S" terminal (c) of the key switch and ground.

*Is battery voltage (approximately 12V) measured?*

<b>Yes</b> ____ The key switch is OK.	<b>No</b> ____ The key switch has failed; replace it.
--	--

6. Re-install the plate to the back of the control console.

The key switch has now been checked.

### 3.4 Checking the Crank Relay

- Prerequisites**
- Multimeter
  - Fully-charged (approximately 12V) battery
  - Functioning 20A main fuse
  - Functioning key switch

**Background** The coil of the crank relay is energized when the key switch is in the START position.

**Procedure** Follow the procedure below to check the crank relay.

1. Open the hood and locate the crank relay (a)

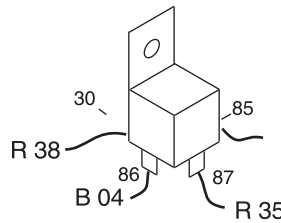
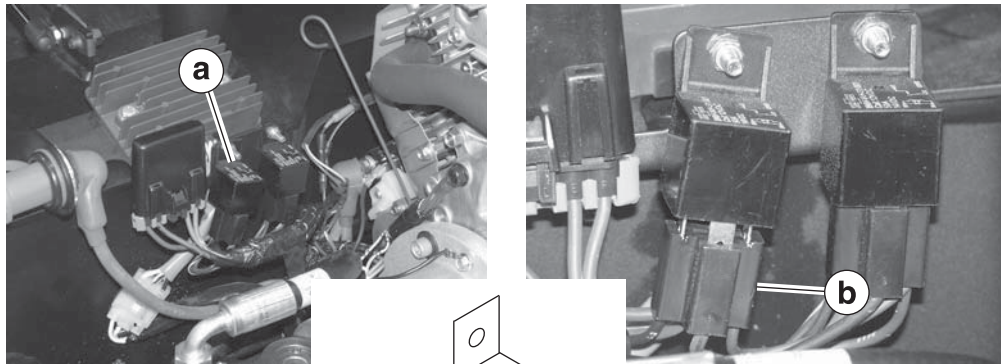

wc\_gr003917

2. Check the voltage between terminal 30 (red wire #38) and ground. This test may be done at the plug (b) with it disconnected from the crank relay.

*Is battery voltage (approximately 12V) measured?*

<b>Yes</b> ____	<b>No</b> ____
Continue	Repair red wire #38.

3. With the key switch in the START position, check the voltage between terminal 86 (black wire #04) and ground. This test may be done at the plug (b) with it disconnected from the crank relay.

*Is battery voltage (approximately 12V) measured?*

<b>Yes</b> ____	<b>No</b> ____
Continue	Repair black wire #04.

4. With the key switch in the START position, check the voltage between terminal 87 and ground (red wire #35). For this test, the plug (b) must be connected to the crank relay. Position the plug as shown to allow access to terminal 87.

*Is battery voltage (approximately 12V) measured?*

<b>Yes</b> ____	<b>No</b> ____
The crank relay is OK.	The crank relay has failed; replace it.

The crank relay has now been checked.



## 3.5 Checking the Neutral Switch

- Prerequisites**
- Multimeter
  - Fully-charged (approximately 12V) battery
  - Functioning main fuse
  - Functioning key switch
  - Seat platform in raised position. See section *Rear Frame Access*.

**Background** The neutral switch, when closed (control lever in NEUTRAL position), allows voltage to the neutral relay.

**Procedure** Follow the procedure below to check the neutral switch.

1. Locate the connector (a) for the neutral switch and disconnect it.

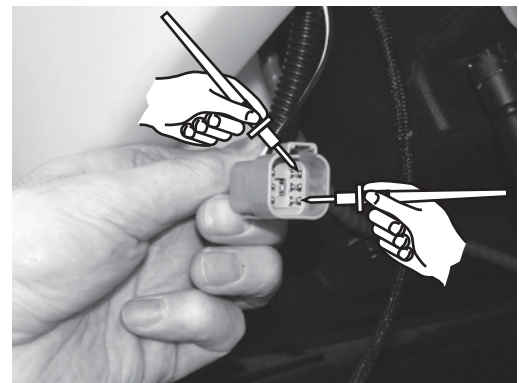
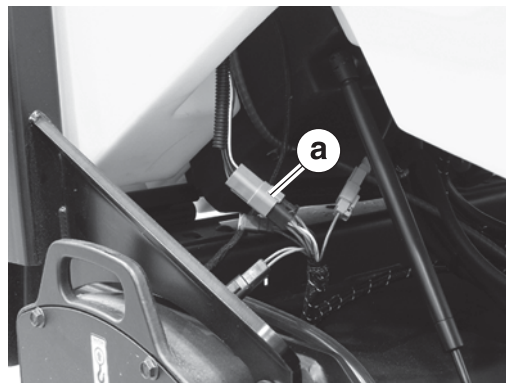

wc\_gr003919

2. Place the control lever in the NEUTRAL position.
3. With the key switch in the START position, check the continuity between the pins of the connector (green and white wires).

*Is there continuity?*

Yes ____	No ____
Continue	The neutral switch has failed; replace it.

4. Place the control lever in the FORWARD or REVERSE position.
5. With the key switch in the START position, check the continuity between the pins of the connector (green and white wires).

*Is there continuity?*

Yes ____	No ____
The neutral switch has failed; replace it.	Continue

6. Repeat the test with the control lever in the REVERSE position.

*Is there continuity?*

Yes ____	No ____
The neutral switch has failed: replace it.	The neutral switch is OK.

7. Reconnect the wiring.
8. Lower and secure the seat platform.  
The neutral switch has now been checked.

### 3.6 Checking the Neutral Relay

- Prerequisites**
- Multimeter
  - Fully-charged (approximately 12V) battery
  - Functioning 20A main fuse
  - Functioning crank relay
  - Functioning neutral switch

**Background** The neutral relay relays battery voltage to the starter solenoid.

**Procedure** Follow the procedure below to check the neutral relay.

1. Open the hood and locate the neutral relay (a).

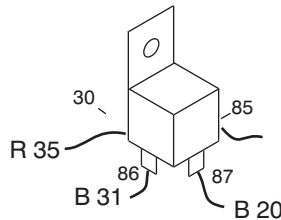
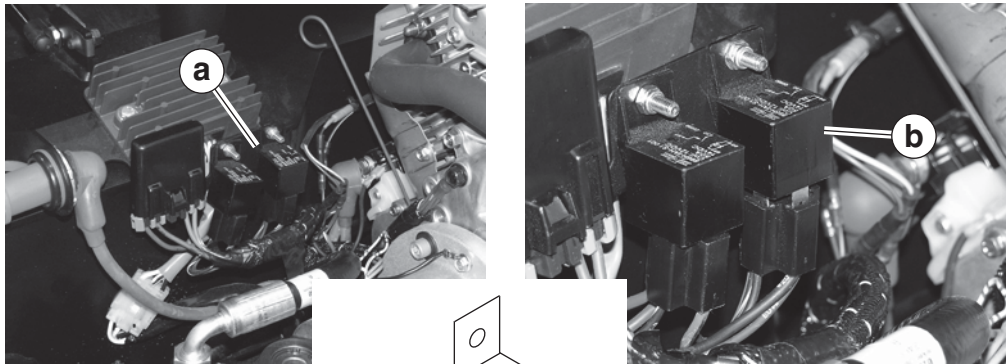

wc\_gr003918

2. Place the key switch in the START position.
3. Check the voltage between terminal 30 (red wire #35) and ground. This test may be done at the plug (b) with it disconnected from the neutral relay.

*Is battery voltage (approximately 12V) measured?*

<b>Yes</b> ____	<b>No</b> ____
Continue	Repair red wire #35.

4. Check the voltage between terminal 86 (black wire #31) and ground. This test may be done at plug (b) with it disconnected from the neutral relay.

*Is battery voltage (approximately 12V) measured?*

<b>Yes</b> ____	<b>No</b> ____
Continue	Repair red wire #31.

5. Check the voltage between terminal 87 (black wire #20) and ground. For this test, plug (b) must be connected to the crank relay. Position the plug as shown to allow access to terminal 87.

*Is battery voltage (approximately 12V) measured?*

<b>Yes</b> ____	<b>No</b> ____
The neutral relay is OK.	The neutral relay has failed; replace it.

The neutral relay has now been checked.

## **4 Wacker Neuson Engine Starting System**

- Prerequisites**
- Before troubleshooting engine starting issues, check the battery and the cable connections to the battery. The battery must be fully charged (approximately 12V).
- 

**Sequence** Complete the troubleshooting in the following sequence:

1. Check the 20A main fuse.
2. Check the wiring to the starter solenoid and to the anti-backfire solenoid.
3. Check the key switch.
4. Check the crank relay.
5. Check the neutral switch.
6. Check the neutral relay.



## 4.1 Checking the 20A Main Fuse

**Prerequisites** ■ Key switch in OFF position.

**Background** There are three 20A fuses protecting the circuits in the RD 12:

- Main electricals
- Voltage regulator circuit
- Optional light circuit

**Procedure** Follow the procedure below to check the 20A main fuse.

1. Open the hood and locate the fuse carrier (a).

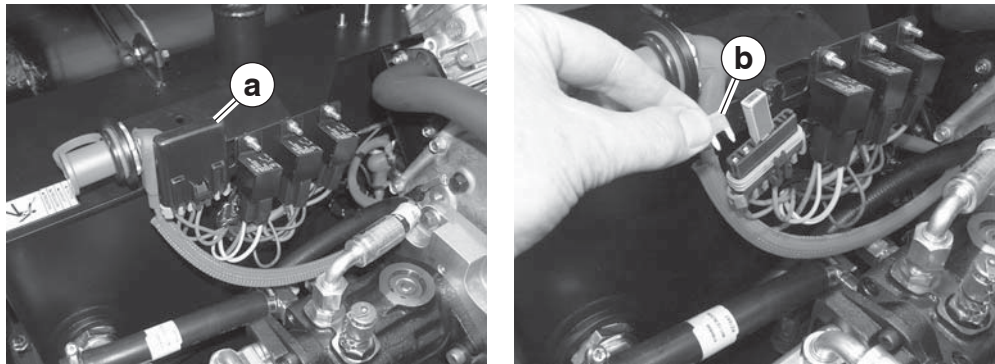

wc\_gr004128

2. Remove the protective cover from the fuse carrier.
3. Check the condition of the 20A main fuse (b).

*Is the 20A fuse OK?*

Yes ____	No ____
Continue	Replace the 20A main fuse with one of same size and rating.

4. Re-install the 20A main fuse and the protective cover to the fuse carrier.

The 20A main fuse has now been checked.

## 4.2 Checking the Wiring to the Starter Solenoid & Anti-backfire Solenoid

**Prerequisites** ■ Fully-charged (approximately 12V) battery

**Background** Black wire #20 delivers 12VDC to the starter solenoid when the key is in the START position. If this wire is broken or disconnected, the engine will not start.

**Procedure** Follow the procedure below to check the wiring to the starter solenoid.

1. Open the hood and locate the starter/starter solenoid (a).

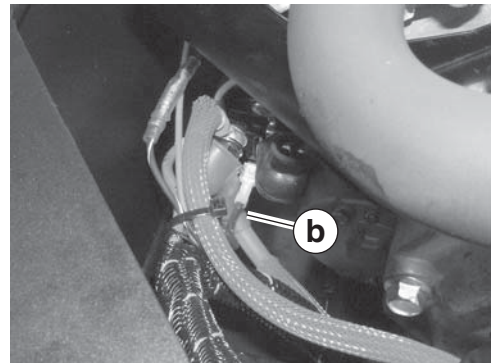
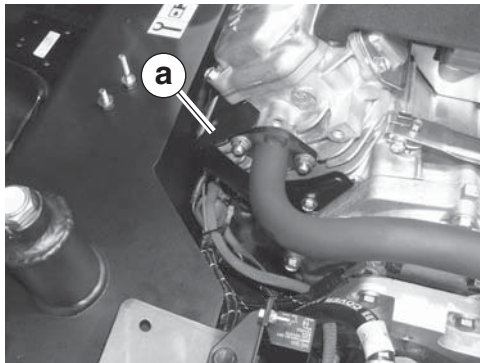

wc\_gr004129

2. Check the condition/connection of black wire #20 (b) to the starter solenoid.  
*Is the wiring OK?*

<b>Yes</b> ____	<b>No</b> ____
Continue	Reconnect or repair red wire.

3. Check the condition and connection of the black/yellow wire to the anti-backfire solenoid.

*Is the wiring OK?*

<b>Yes</b> ____	<b>No</b> ____
The wiring is OK.	Reconnect or repair red wire.

4. If the engine still won't start but cranks, remove the anti-backfire solenoid (c) and clean the valve portion of it with carburetor cleaner. Re-install it and try to start the engine.

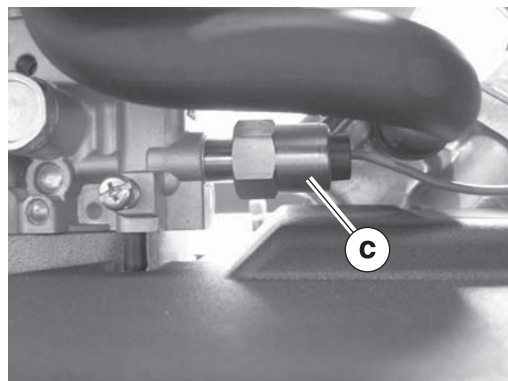

wc\_gr005344

The wiring to the starter solenoid and anti-backfire solenoid has now been checked.

### 4.3 Checking the Key Switch

- Prerequisites**
- Multimeter
  - Fully-charged (approximately 12V) battery
  - Functioning 20A main fuse

**Background** The key switch is a three-position switch: ON, START, and OFF. When in the START position, the key switch directs battery voltage to the crank relay.

**Procedure** Follow the procedure below to check the key switch.

1. Remove the screws that secure the plate (a) to the back of the control panel and remove the plate.

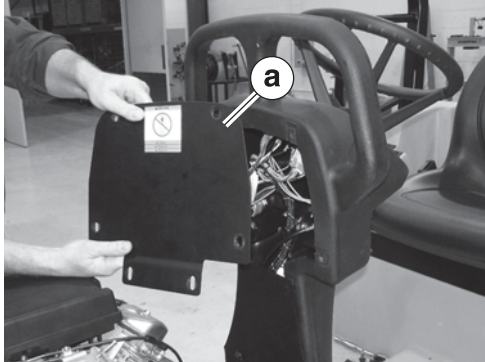

wc\_gr004201

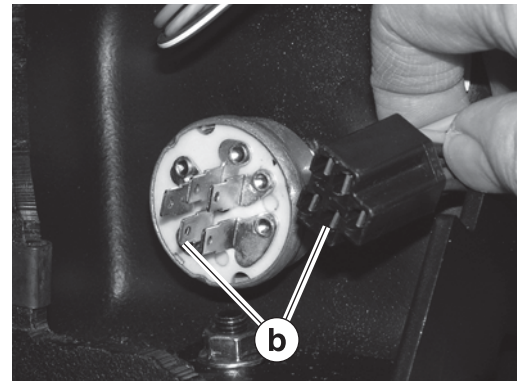

wc\_gr003915

2. Using the multimeter, check the voltage between the BAT terminal (b) of the key switch and ground. For easier measuring, remove the plug and measure voltage at the plug.

*Is battery voltage (approximately 12V) measured?*

Yes ____	No ____
Continue	Check the continuity of red wire #13 between the key switch and 20A main fuse. Repair red wire #13 as needed.

3. Place the key switch in the START position.
4. Re-install the plug to the key switch.

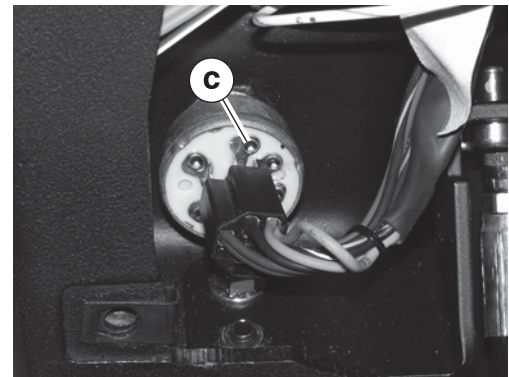

wc\_gr003916

5. Check the voltage between the "S" terminal (c) of the key switch and ground.

*Is battery voltage (approximately 12V) measured?*

Yes ____	No ____
The key switch is OK.	The key switch has failed; replace it.

6. Re-install the plate to the back of the control console.

The key switch has now been checked.

### 4.4 Checking the Crank Relay

- Prerequisites**
- Multimeter
  - Fully-charged (approximately 12V) battery
  - Functioning 20A main fuse
  - Functioning key switch

**Background** The coil of the crank relay is energized when the key switch is in the START position.

**Procedure** Follow the procedure below to check the crank relay.

1. Open the hood and locate the crank relay (a).

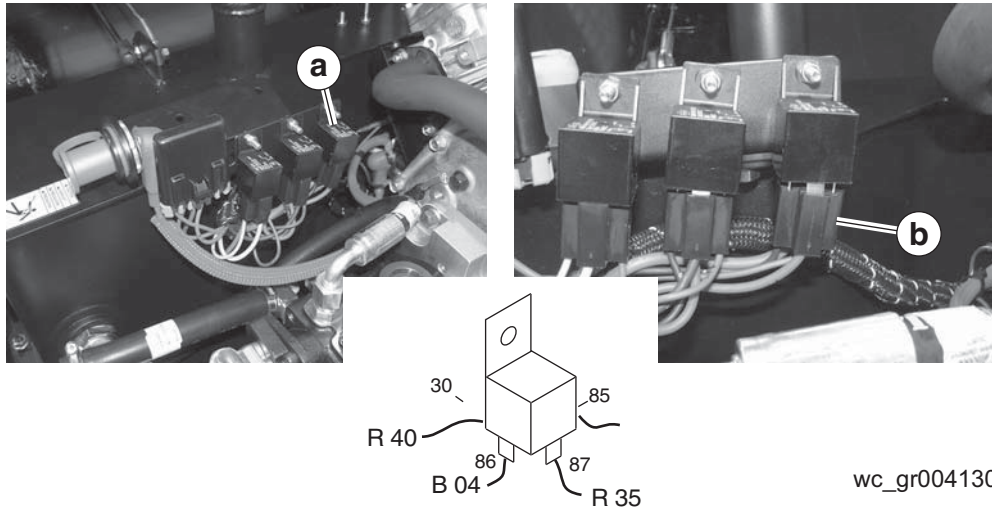

wc\_gr004130

2. Check the voltage between terminal 30 (red wire #40) and ground. This test may be done at the plug (b) with it disconnected from the crank relay.

*Is battery voltage (approximately 12V) measured?*

<b>Yes</b> ____	<b>No</b> ____
Continue	Repair red wire #40.

3. With the key switch in the START position, check the voltage between terminal 86 (black wire #04) and ground. This test may be done at the plug (b) with it disconnected from the crank relay.

*Is battery voltage (approximately 12V) measured?*

<b>Yes</b> ____	<b>No</b> ____
Continue	Repair black wire #04.

4. With the key switch in the START position, check the voltage between terminal 87 and ground (red wire #35). For this test, the plug (b) must be connected to the crank relay. Position the plug as shown to allow access to terminal 87.

*Is battery voltage (approximately 12V) measured?*

<b>Yes</b> ____	<b>No</b> ____
The crank relay is OK.	The crank relay has failed; replace it.

The crank relay has now been checked.

## 4.5 Checking the Neutral Switch

- Prerequisites**
- Multimeter
  - Fully-charged (approximately 12V) battery
  - Functioning main fuse
  - Functioning key switch
  - Seat platform in raised position. See section *Rear Frame Access*.

**Background** The neutral switch, when closed (control lever in NEUTRAL position), allows voltage to the neutral relay.

**Procedure** Follow the procedure below to check the neutral switch.

1. Locate the connector (a) for the neutral switch and disconnect it.

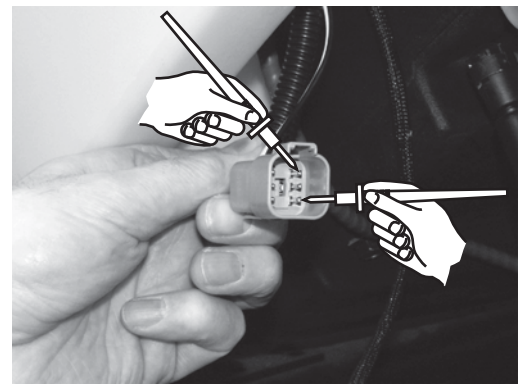
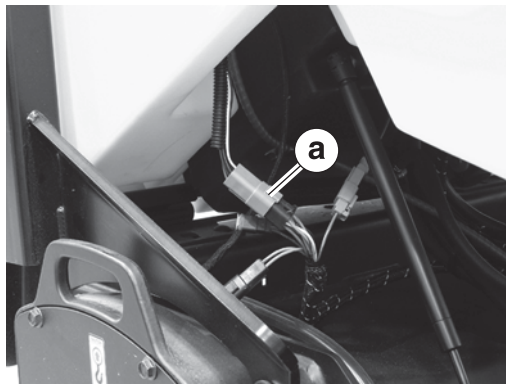

wc\_gr003919

2. Place the control lever in the NEUTRAL position.
3. With the key switch in the START position, check the continuity between the pins of the connector (green and white wires).

*Is there continuity?*

Yes ____	No ____
Continue	The neutral switch has failed; replace it.

4. Place the control lever in the FORWARD or REVERSE position.
5. With the key switch in the START position, check the continuity between the pins of the connector (green and white wires).

*Is there continuity?*

Yes ____	No ____
The neutral switch has failed; replace it.	Continue

6. Repeat the test with the control lever in the REVERSE position.

*Is there continuity?*

Yes ____	No ____
The neutral switch has failed: replace it.	The neutral switch is OK.

7. Reconnect the wiring.
  8. Lower and secure the seat platform.
- The neutral switch has now been checked.



4.6 Checking the Neutral Relay

- Prerequisites**
- Multimeter
  - Fully-charged (approximately 12V) battery
  - Functioning 20A main fuse
  - Functioning crank relay
  - Functioning neutral switch

**Background** The neutral relay relays battery voltage to the starter solenoid.

**Procedure** Follow the procedure below to check the neutral relay.

1. Open the hood and locate the neutral relay (a).

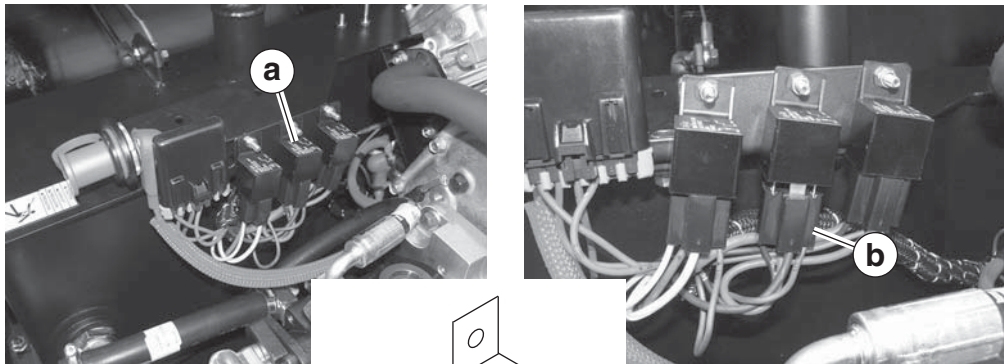

wc\_gr004131

2. Place the key switch in the START position.
3. Check the voltage between terminal 30 (red wire #39) and ground. This test may be done at the plug (b) with it disconnected from the neutral relay.

*Is battery voltage (approximately 12V) measured?*

<b>Yes</b> ____	<b>No</b> ____
Continue	Repair red wire #39.

4. Check the voltage between terminal 86 (black wire #31) and ground. This test may be done at the plug (b) with it disconnected from the neutral relay.

*Is battery voltage (approximately 12V) measured?*

<b>Yes</b> ____	<b>No</b> ____
Continue	Repair red wire #31.

5. Check the voltage between terminal 87 (black wire #20) and ground. For this test, the plug (b) must be connected to the crank relay. Position the plug as shown to allow access to terminal 87.

*Is battery voltage (approximately 12V) measured?*

Yes _____	No _____
The neutral relay is OK.	The neutral relay has failed; replace it.

The neutral relay has now been checked.

## 5 Drive System

**Background** The hydraulic system is powered by two pumps (exciter and drive) mounted in tandem—connected along their shafts through a solid-mounted coupling—and driven directly by the engine crankshaft through a flex coupling.

---

**Drive Pump**

- The drive pump is a variable displacement, axial piston pump and includes an integral charge pump.
- Flow through the drive pump is controlled by varying its displacement through the movement of the control lever coupled to the pump's control shaft. This allows a full range of operating speeds in both forward and reverse.
- The drive pump includes pressure test ports for the drive system.
- The drive pump also includes the towing valve which, when open, allows oil flow to bypass the drive motors.

---

**Drive Motors**

- There are two drive motors—one mounted to each drum.
- The drive motors are plumbed in series.

---

**System filters and strainers**

- The hydraulic tank is equipped with a strainer at the fill port to trap large objects or particles which may accidentally fall into the tank while adding hydraulic fluid.
- Additional system protection is provided by a suction filter mounted in-line with the exciter pump inlet.
- The hydraulic system is protected by a return-line filter which removes dirt particles down to 10 microns and includes a flow bypass for cold weather start-up.

---

**Troubleshooting sequence** When troubleshooting drive system problems, do so in the following sequence:

1. Check the tow (bypass) valve.
2. Check the function of the drive control cable.
3. Pressure test the drive pump and relief valve.
4. Check the drive motors for binding.
5. Check the oil flow through the drive motors.



## 5.1 Checking the Tow Valve

**Background** In order for the machine to operate properly, the tow valve must be completely closed.

---

**Procedure** Follow the procedure below to open and close the tow valve.

---



**WARNING!** With the tow valve open, the drive circuit has no braking action and the machine will roll freely.

- ▶ Close the tow valve immediately after a towing operation is complete to prevent the machine from rolling unexpectedly.
- 

1. Turn the shaft of the valve (**a**) counterclockwise 90° to open the tow valve.

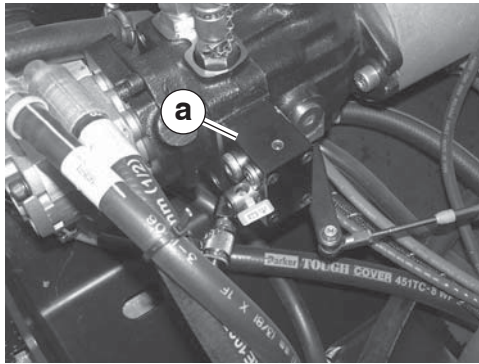

wc\_gr004120

2. Turn the shaft of the tow valve fully clockwise to close the tow valve.  
The tow valve has now been checked.

## 5.2 Adjusting the Drive Control Cable

**Background** If the roller tends to drift in either direction when the forward/reverse control is in NEUTRAL, the drive control cable (**a**) must be adjusted.

- Prerequisites**
- Machine on a hard, level surface
  - Engine running
  - Forward/reverse control in the NEUTRAL position

**Procedure** Follow the procedure below to adjust the drive control cable.

1. Loosen the lock nut (**b**).

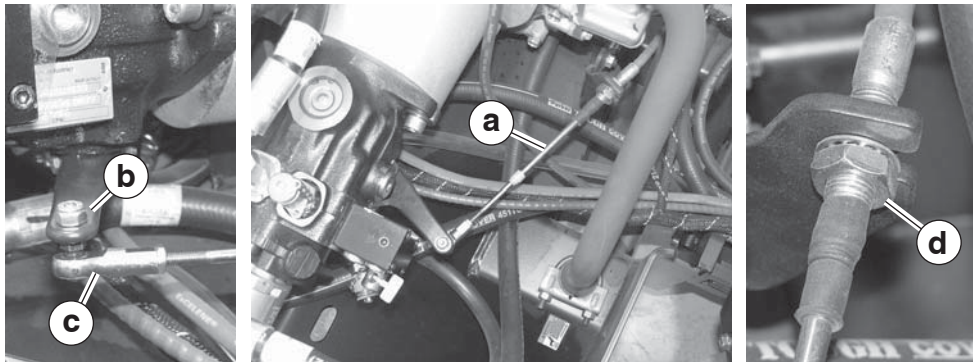

wc\_gr004121

2. Move the turnbuckle (**c**) as needed until machine movement stops. If adjusting the turnbuckle does not achieve the desired results, a gross adjustment can be made at the nut (**d**) and then fine-tuned as described above.

The drive control cable has now been adjusted.

### 5.3 Checking the Drive System Operating Pressure

**Background** Failure of the drive circuit to reach operating pressures is normally caused by a worn or damaged drive pump; however, the problem could also be the result of a badly worn motor.

- Prerequisites**
- Machine on a firm, level surface
  - 3000-psi pressure gauge
  - Hydraulic oil warm

**Procedure** Follow the procedure below to test the drive system operating pressure.

1. Install a 3000-psi gauge in the forward test port **(a)** on the drive pump.

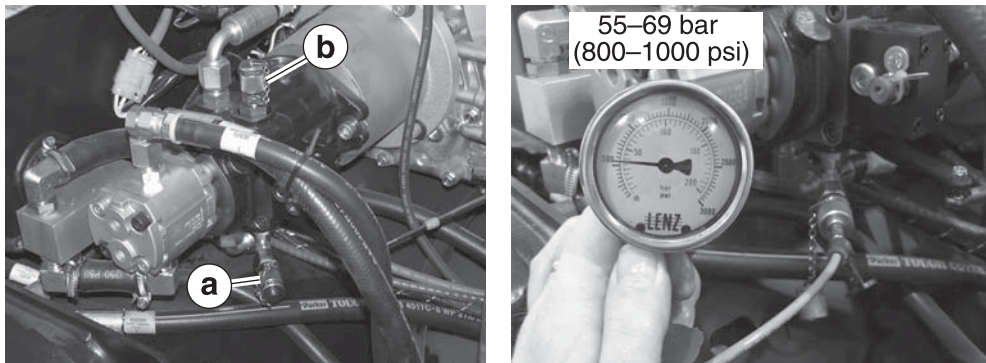

wc\_gr004122

2. Start the engine and run the machine at full throttle.
3. Shift the control lever to forward and record the pressure on the gauge.
4. Stop the engine.
5. Install the gauge in the reverse test port **(b)** and repeat the procedure while operating in reverse.

**Note:** *Operating pressures will increase significantly when running the machine uphill, off road, or against an object.*

The drive system operating pressure has now been checked.

## 5.4 Checking the Drive System Relief Pressure

- Prerequisites**
- Machine on a firm, level surface
  - 5000-psi pressure gauge

**Procedure** Follow the procedure below to check the relief pressure.

1. Place blocks in front of and behind both drums to prevent the machine from moving, or dead head the machine against a solid concrete abutment.
2. Set the parking brake.



**CAUTION!** Crushing hazard.

- ▶ To reduce the risk of injury, make sure no one is in front of or behind the machine during this test.

3. Install a 5000-psi gauge in the forward test port **(a)** on the drive pump.

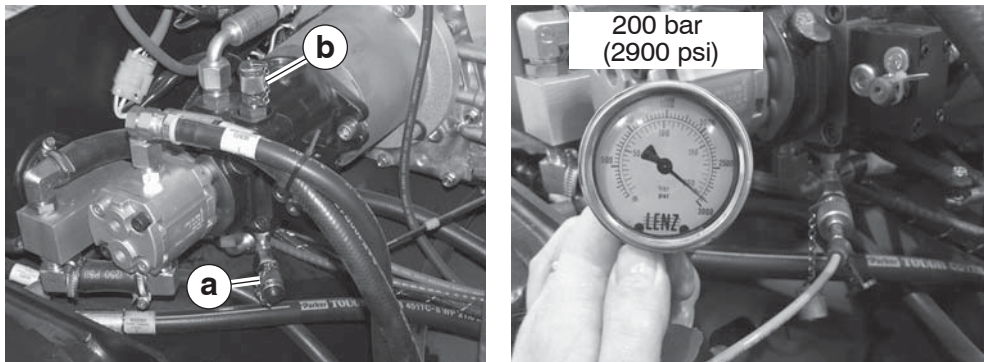

wc\_gr004124

4. Start the engine and run the machine at full throttle.
5. Shift the forward/reverse control slowly into forward until pressure on the gauge tops out. This is the forward relief valve pressure.

**Note:** *Make sure the drums do not spin.*

6. Install the gauge in the reverse test port **(b)** and repeat the procedure while operating in reverse.

The relief pressure has now been checked.

## 5.5 Checking Drive Motors for Binding

**Background** High operating pressures indicate binding in the drive system. Binding can occur in the drive motor or may be the result of a poor or failing drive bearing.

- Prerequisites**
- Machine stopped
  - Parking brake ON
  - Battery disconnected
  - Jacks

**Procedure** To check for binding in the drive motor:

1. Remove the drive motor cover (a).

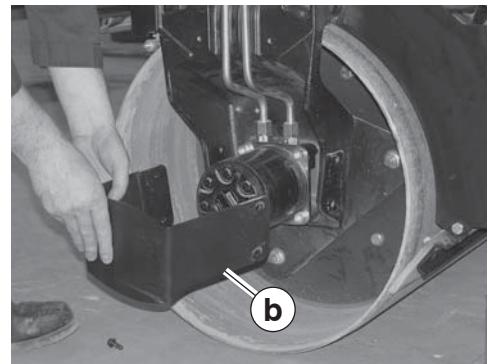
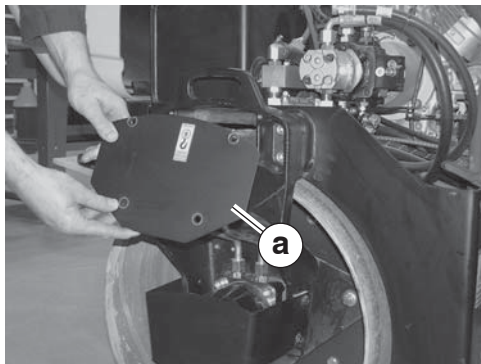

wc\_gr004125

2. Remove the drum support cover (b).
3. Support the machine before separating the drive plate from the drum by placing blocks or jacks (c) under the front frame just behind the drum.

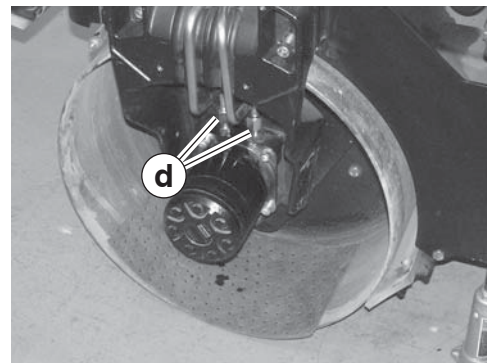
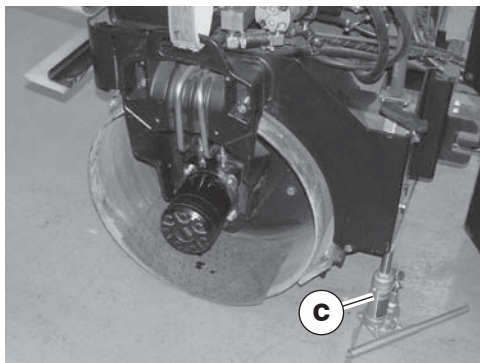

wc\_gr004126

4. Disconnect the hydraulic lines (d) to the drive motor.
- This procedure continues on the next page.*

*Continued from the previous page.*

5. Secure the drum support with an appropriate crane and sling (**e**).
6. Remove the screws that secure the drum support and remove the drum support.

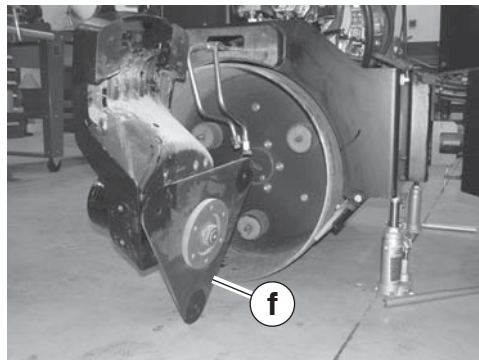
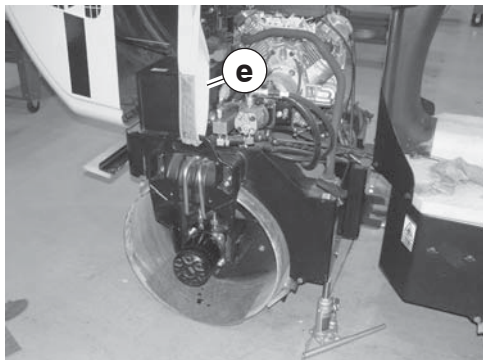

wc\_gr004127

7. Rotate the drive plate (**f**) by hand and make sure the motor turns freely.

The drive motor has now been checked for binding.



## 5.6 Checking Oil Flow through the Drive Motors

**Background** The drive motors are plumbed in series. Oil flow through one motor is virtually identical to the flow through the other, unless a problem with one of the motors exists.

---

**Procedure** Follow the procedure below to check oil flow through the motors.

---



**WARNING!** Crushing hazard.

- ▶ Use extreme care when carrying out the following procedure.
- 

1. Start the engine and allow the hydraulic oil to warm up. Shut off the engine.
  2. Using a crane or overhead lift with enough load-bearing capacity to support the machine, lift the machine off the ground so that the drums are 2–5 cm (1–2 inches) off the ground.
  3. Place a piece of tape on or boldly mark each drum. This will aid in observing the rotation of the drums.
  4. Start the engine and slowly shift the forward/reverse control lever into the FORWARD position. Observe the drum rotation for any sign of difference in the rotation of the drums. If one drum is rotating slower than the other, the drum with the slower rotation may be failing.
  5. With the engine running and the drums rotating, slowly apply the parking brake to the rear drum. Observe the speed of both drums as the brake is applied. Both drums should slow down at the same rate. Apply the brake until the rear drum stops rotating. **Note:** *If the brake cannot stop the rear drum from rotating, the brake requires repair or replacement.* With the rear drum held from rotating by the brake, the front drum should not be rotating. If it is, the seals of the rear drive motor are failing. Rebuild or replace the rear drive motor.
  6. Release the brake from the rear drum.
  7. Conduct the same test on the front drum. Use a sturdy piece of wood, such as a 2x4, as an external brake.
- 



**WARNING!** Crushing hazard.

- ▶ Do not jam the piece of wood between the drum and the floor. The roller will move.
- 

Wedge the sturdy piece of wood between the drum and the **machine frame** to stop the drum rotation.

If the rear drum rotates when the front drum is held from rotating by the external brake, the seals of the front drive motor are failing. Rebuild or replace the front drive motor.

The oil flow through the drive motors has now been checked.

## 6 Vibration System and Steering

Both the vibration and steering system share the same open loop, series circuit, driven by a fixed displacement, gear-type pump (exciter pump). The system includes separate relief valves for vibration and steering, an exciter control valve exciter motor, steering valve, and steering cylinder.

---

### Vibration circuit

The exciter pump pulls oil from the tank through the suction filter and sends it to the exciter manifold block. The vibration circuit is controlled by the exciter solenoid valve. This valve is electrically operated by an ON/OFF switch located on the end of the forward/reverse control lever. Supply oil from the exciter pump is directed to the exciter control valve. When the ON/OFF switch is in the OFF position, the exciter control valve is open, allowing oil to pass downstream to the steering valve without driving the exciter motor. When the ON/OFF switch is in the ON position, the exciter control valve closes and directs oil to the exciter motor which drives the eccentric weights in the front drum. Return oil from the exciter motor flows to the steering valve. A relief valve connected across the exciter control valve limits pressure to 200 bar (2900 psi).

---

### Steering circuit

Steering is controlled by a steering valve and cylinder. The steering wheel is spline-mounted directly to the steering valve. The steering valve reacts to the motion of the steering wheel to direct oil to and from the steering cylinder. Oil returning from the vibration circuit is directed to the steering valve. If steering is inactive, oil passes through the steering valve and back to the return-line filter manifold. When the steering wheel is turned, the steering valve closes and directs oil to the appropriate steering line to extend or retract the cylinder.

A relief valve is connected across the steering valve and is set at 45–51 bar (650–725 psi). Relief valves are also connected to each end of the steering cylinder. Each of these relief valves is also set at 45–51 bar (650–725 psi).

The oil returning from the vibration and steering functions is directed back to the tank through a return-line filter. A filter bypass relief valve, set at 1.7 bar (25 psi), protects the return-line filter by routing oil past the filter if the filter is clogged.

---

### Troubleshooting sequence

When troubleshooting:

- For systems that vibrate poorly, see section *Troubleshooting a System that Vibrates Poorly*.
- For complete vibration system failure, see sections *Checking the Vibration Solenoid Valve* and *Checking the Vibration Switch*.



## 6.1 Checking the Engine Speed and Vibration Speed

- Prerequisites**
- Vibrotach
  - Vibration must turn on

**Procedure** Follow the procedure below to check the engine rpm and drum vpm.

1. Start the engine and place the throttle switch in the FAST position.
2. Measure the engine rpm using a vibrotach.

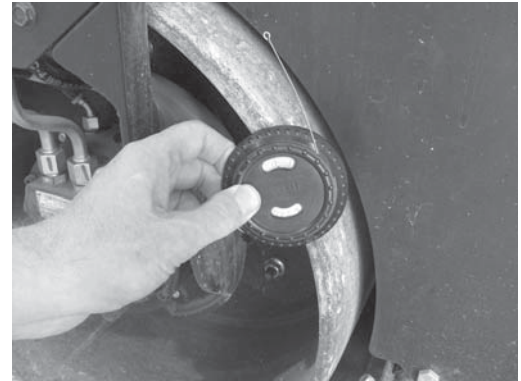
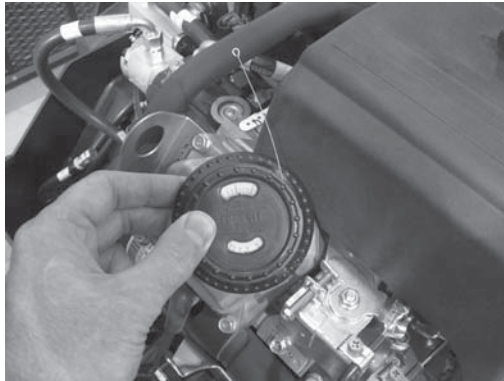

wc\_gr005397

3. Measure the vpm (vibrations per minute) by placing the vibrotach on the rim of the drum while vibration is on.
4. If the vpm is not 4150–4250, adjust the throttle screw (**a**) until it is.

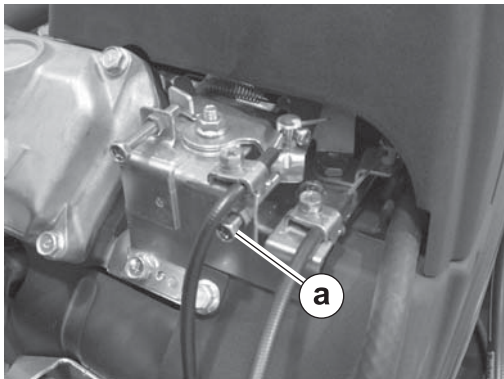

wc\_gr005398

The procedure to check the engine rpm and drum vpm is now complete.

## 6.2 Troubleshooting a System that Vibrates Poorly

- Prerequisites**
- 3000-psi pressure gauge
  - Compactible surface such as a bed of gravel or old tires

**Background** The exciter pump is designed to put out a constant flow of oil at a set engine speed. This ensures that the vibration frequency remains steady. When troubleshooting the exciter circuit, the vibration speed, operating pressure, and relief pressures must be known to help determine the cause of any problems.

- Procedure** To measure vibration speed:
1. Start the machine and run it for several minutes to bring the hydraulic fluid up to normal operating temperature.
  2. Drive the machine onto a compactible surface such as a bed of gravel or old tires.
  3. Run the machine at full throttle. Check the engine RPM using a tachometer or vibrotach. The engine must be running at the correct RPM to accurately measure vibration.
  4. Start vibration. Hold the vibrotach (P/N 53397) against the outer rim of the drum and measure the vibration speed.

Engine RPM	Vibration Frequency VPM
3100	4200

5. Shut down the machine.

To check vibration system operating pressure:

1. Open the engine compartment.
2. Locate the exciter solenoid valve (a).

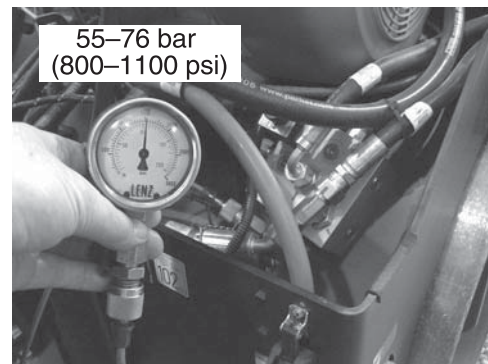
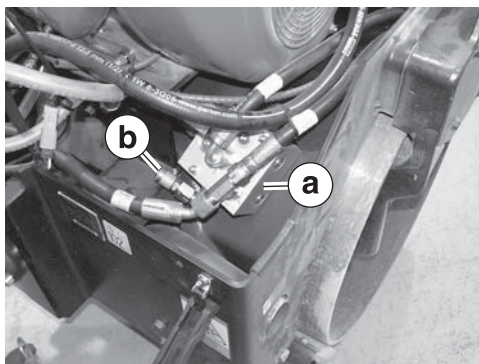

wc\_gr004142

3. Connect a 3000-psi gauge to the test port (b).
4. Start the engine and run the machine at full throttle.

*This procedure continues on the next page.*

*Continued from the previous page.*

5. Turn on the vibration and measure the relief and operating pressures. The relief pressure is the pressure registered on the gauge as soon as the vibration is turned on. The system will then settle into operating pressure. Record these two pressures.
6. Shut down the machine.

Compare the results from operating pressure, pump relief pressure, and exciter speed with the chart below.

Operating Pressure	Pump Relief Pressure	Exciter Speed	Probable Cause
N	N	N	System OK
H	N	N or L	Exciter bearings or motor binding
N or L	N	L	Exciter motor worn
L	L	L	Exciter pump damaged or worn, relief valve defective, or needs adjusting

N = Normal, L = Low, H = High

If the exciter is binding or causing high operating pressures, perform the following:

1. Disconnect and remove the exciter motor (c) from the housing.
2. Turn the motor shaft and exciter shaft by hand and check that they both turn freely.

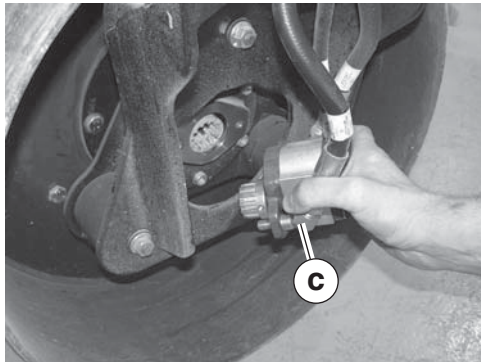

wc\_gr004143

3. If either component does not turn freely, it has failed; replace it.

The vibration system has now been checked for poor vibration.

### 6.3 Checking the Vibration Solenoid Valve

**Background** When the roller’s engine is running, the solenoid (a) of the vibration manifold (b) receives power through the white wire via the vibration switch. When energized, the vibration solenoid valve shifts causing oil flow to the exciter motor. To check the function of the vibration electrical system, both the vibration solenoid and the vibration switch should be tested.

**Procedure** Follow the procedure below to check the vibration solenoid.

1. Place the key switch in the ON position.
2. With your hand around the body of the vibration solenoid (a), turn the vibration switch ON and feel for movement of the plunger inside the vibration solenoid.  
**Note:** If the movement of the plunger is hard to detect, remove the solenoid from the vibration manifold to make it easier.

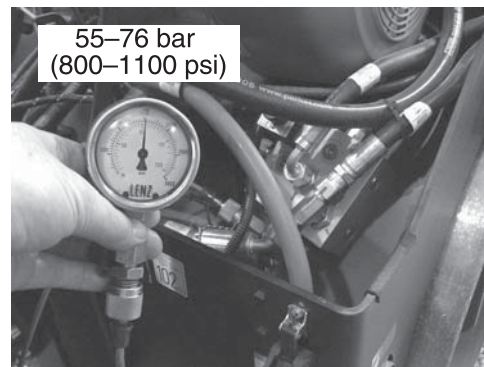
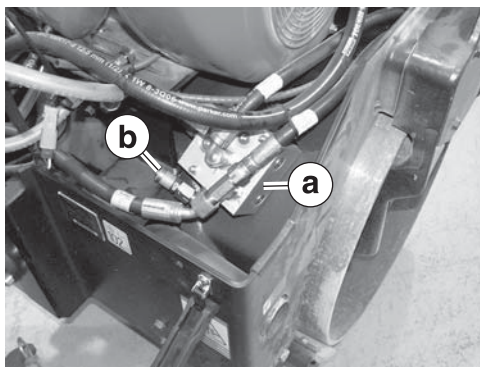

wc\_gr004142

Is the vibration solenoid functioning?

Yes ____	No ____
Any problems with vibration are in the hydraulic circuit, not the electrical system.	Continue

3. Disconnect the vibration solenoid from the harness.
4. Place the vibration switch in the ON position and measure the voltage across the connector (b).

Is 12VDC (battery voltage approximately 12V) measured?

Yes ____	No ____
The vibration solenoid is receiving power and should be functioning. If it is not, it has failed; replace it.	Continue troubleshooting by checking the vibration switch.

The vibration solenoid has now been checked.

## 6.4 Checking the Vibration Switch

**Background** When the roller's engine is running, the solenoid of the vibration manifold receives power through the white wire via the vibration switch. To check the function of the vibration electrical system, both the vibration solenoid and the vibration switch should be tested.

**Procedure** Follow the procedure below to check the vibration switch.

1. Remove the four screws that secure the seat platform. Then, raise the platform.

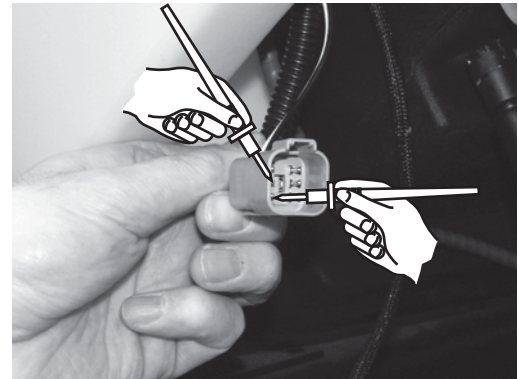
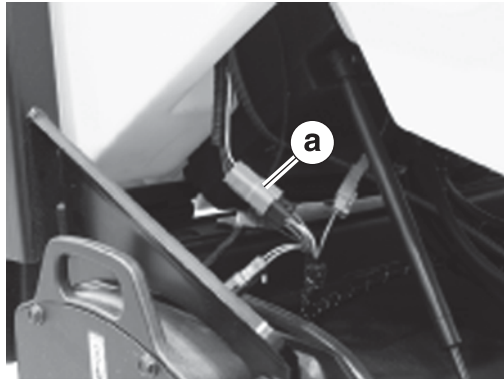

wc\_gr004038

2. Locate the connector (**a**) for the vibration switch and disconnect it.
3. Press the switch several times while checking for continuity between the pins of the connector (two black wires).

*Does the switch open and close*

Yes ____	No ____
The vibration switch is OK.	The vibration switch has failed; replace it.

4. Reconnect the wiring.

The vibraton switch has now been checked.



## 7 Steering System

### 7.1 Checking the Steering System Hydraulic Pressure

**Prerequisites** 200-bar (3000-psi) pressure gauge

**Procedure** Follow the procedure below to check the steering system hydraulic pressure.

1. Open the engine compartment.
2. Locate the exciter solenoid valve (**a**).

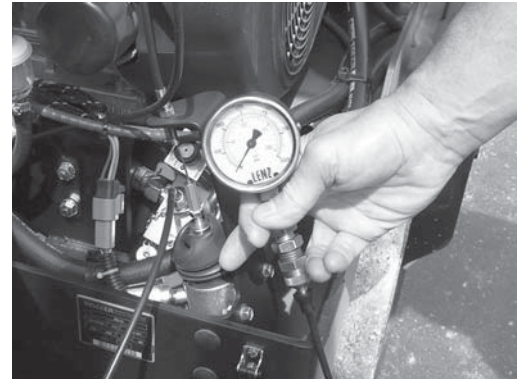
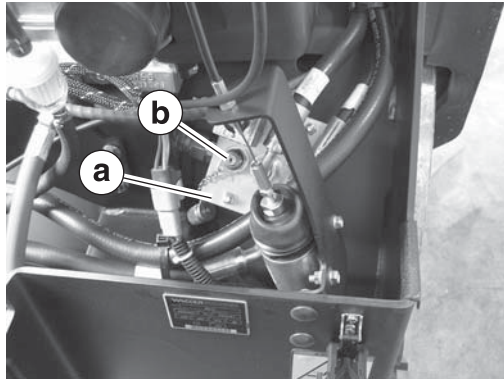

wc\_gr005347

3. Connect a 200-bar (3000-psi) gauge to the test port (**b**).
4. Start the engine.
5. Check the pressure while operating the steering. See section *Technical Data* for values.

**NOTICE:** Do not turn on the vibration while conducting this test. The 3000-psi gauge will be damaged.

6. Remove the gauge.

The steering system hydraulic pressure has now been checked.

## 7.2 Troubleshooting the Steering System

**Background** Low hydraulic pressure in the steering circuit can be the result of a defective or worn steering valve or poor seals in the steering cylinder.

A badly worn exciter pump will affect both the steering and the vibration circuits because these circuits operate in series using the same supply.

**Note:** *In some cases the exciter pump may function well enough to operate the steering circuit but not the vibration circuit. This is due to the much lower pressure requirements of the steering circuit.*

**Procedure** Follow the procedure below to check the steering system.

1. Remove the steering valve from the machine. See section *Removing the Steering Valve*.



**WARNING!** There is no steering control with the steering valve removed.

- ▶ DO NOT drive the machine with the steering cylinder disconnected or inoperative!

2. Cap the hydraulic lines that feed the steering valve.
3. Start the engine.
4. Check the steering circuit relief pressure.

If	Then
Hydraulic pressure remains low	Problem is in the steering valve
Hydraulic pressure increases	Problem is in the steering cylinder

The steering system has now been checked.

## **8 Spray System**

### **8.1 Troubleshooting the Spray System**

**Prerequisites** The machine must be able to start in order to troubleshoot the spray system. If the machine does not start, see engine starting troubleshooting.

---

**Components** The electrical components of the spray system consist of:

- Pump
- Pump timer module
- Spray system switch

---

**Sequence** When troubleshooting the spray system, do so in the following sequence:

1. Check power to the pump.
2. Check the pump timer module.
3. Check the spray system switch.



## 8.2 Checking Power to the Spray Bar Pump

**Prerequisites** Seat platform in raised position. See section *Rear Frame Access*.

**Procedure** Follow the procedure below to check power to the spray bar pump.

1. Disconnect the wiring from the water pump (a).



wc\_gr004571

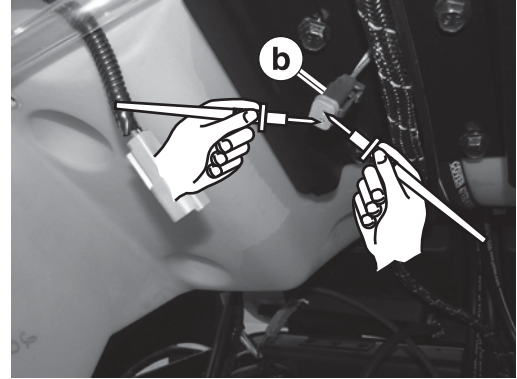

wc\_gr004234

2. Place the key switch in the ON position.
3. Place the spray system switch in the ON position.
4. Measure the voltage at the connector (b).

*Is more than 9.8V measured?*

Yes _____	No _____
The pump has failed; replace it.	See section <i>Checking Power to Pump Timer Module</i> .

The procedure for checking the power to the spray bar pump is now complete.

## 8.3 Checking the Pump Timer Module

- Background** The pump timer module is fed power in two locations:
- Via key switch on pink wire #01
  - Via spray system switch on pink wire #18

**Procedure** Follow the procedure below to check power to the pump timer module.

1. Remove the control console cover (a).

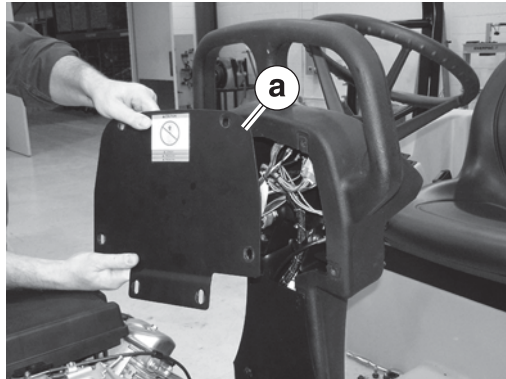

wc\_gr004572

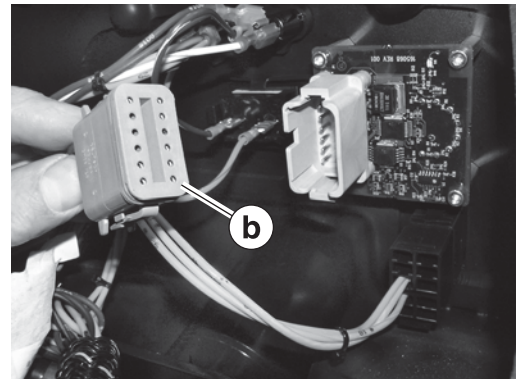

wc\_gr004236

2. Disconnect the pump timer module connector (b).
3. Measure the voltage between pink wire #01 (connector pin 1) and ground.  
*Is more than 9.8V measured?*

<b>Yes</b> ____	<b>No</b> ____
Continue	Repair or replace pink wire #1.

4. Place the key switch in the ON position.
5. Place the spray system switch in the ON position.
6. Measure the voltage between pink wire #18 (connector pin 11) and ground.  
*Is more than 9.8V measured?*

<b>Yes</b> ____	<b>No</b> ____
The pump timer module is receiving power and should be working; continue.	Repair or replace pink wire #18.

7. Reconnect the pump timer module connector.
8. Measure the voltage between pink wire #18 (backprobe connector pin 6) and ground.

**Note:** *The voltage will be intermittent depending on the setting of the pump timer dial.*  
*Is more than 9.8V measured?*

<b>Yes</b> ____	<b>No</b> ____
The pump timer module is functioning.	The pump timer module has failed; replace it.

9. Re-install the control console cover.

The pump timer module has now been checked.

### 8.4 Checking the Spray System Switch

**Background** The spray system switch is fed power via the key switch on pink wire #29. When in the ON position, the spray system switch allows power to the pump control timer via pink wire #18.

**Procedure** Follow the procedure below to check the spray system switch.

1. Remove the control console cover (a).

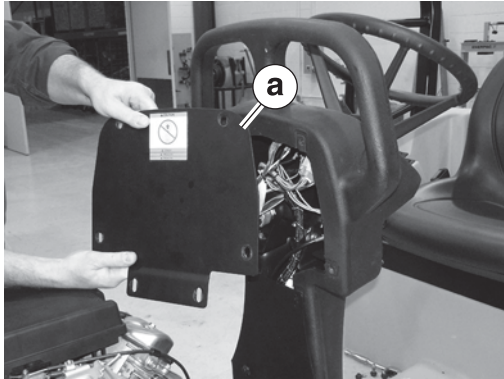

wc\_gr004572

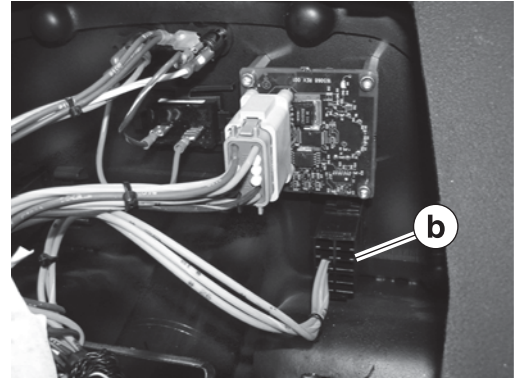

wc\_gr004235

2. Place the key switch in the ON position.
3. Measure the voltage between the incoming side of the spray system switch (b) (pink wire #29) and ground.

*Is more than 9.8V measured?*

Yes ____	No ____
Continue	Check the continuity of pink wire #29. Repair or replace pink wire #29.

4. Place the spray system switch in the ON position.
5. Measure the voltage between the outgoing side of the spray system switch (pink wire #18) and ground.

*Is more than 9.8V measured?*

Yes ____	No ____
The spray system switch is functioning.	The spray system switch has failed; replace it.

The spray system switch has now been checked.

## 9 Disassembly & Assembly

### 9.1 Tools Required for Disassembly/Assembly Procedures

- It is up to the mechanic to use common sense and good judgment in tool selection to reduce the risk of injury while repairing the machine.
  - In cases where a special tool is required, the special tool is listed in the prerequisite section of the procedure.
  - Before substituting another tool or procedure from those recommended in this manual, the mechanic must be satisfied that neither personal injury nor damage to the machine will result due to the substitution.
- 

### 9.2 Information Regarding Replacement Parts

- The repair procedures contained in this manual do not include part numbers.
  - For replacement parts information, refer to the Parts Book originally supplied with the machine.
  - If the original Parts Book has been lost, a replacement may be ordered from Wacker Neuson Corporation.
  - When ordering a replacement Parts Book, please list the model number, item number, revision level, and serial number of the machine.
  - Parts Books are also available on the Wacker Neuson Corporation Web site. See [www.wackerneuson.com](http://www.wackerneuson.com). Enter the site as a visitor.
- 

### 9.3 Information Regarding Reference Numbers ( )

Repair procedures contain reference numbers enclosed in parentheses ( ). These numbers refer to the item numbers shown on the assembly drawings and other detailed drawings. They are included to aid the mechanic in identifying parts and assembling components.

### 9.4 Information Regarding Threadlocking Compounds

**Background** Due to the heavy vibration inherent in this type of equipment, the repair and service procedures described in this manual specify the use of threadlocking compounds. These compounds should be used where indicated to prevent the fasteners from becoming loose.

---

**Recommended threadlockers** Although Loctite® is referred to throughout this manual, any equivalent type of sealant such as Hernon®, Prolock, or Omnifit may be used. For a complete list of recommended sealing and locking compounds, refer to the Use of Threadlockers and Sealants chart at the end of this manual.

---

**Applying threadlockers** Clean the screw threads and wipe off any oil or grease before applying a threadlocking compound.

## 9.5 Removing the Articulating Joint

**Prerequisites** ■ Crane and jacks

**Procedure** Follow the procedure below to remove the articulating joint.

1. Support the rear half of the machine with jacks and the front half with an appropriate crane so that the machine will not fall in on itself when the articulating joint is removed.
2. Disconnect the steering cylinder (a) from the pivot plate (b).

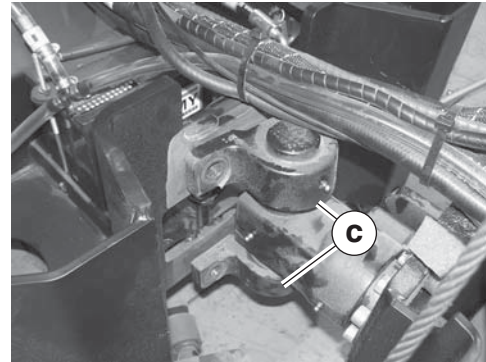
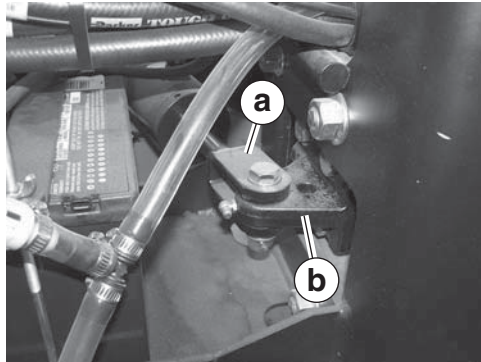

wc\_gr004136

3. Remove the screws that secure each of the pillow blocks (c) to the frame.
4. Rotate/spread the machine halves as needed to better access to the articulating joint.
5. Remove the screws that secure the pivot plate (b) and remove the pivot plate.

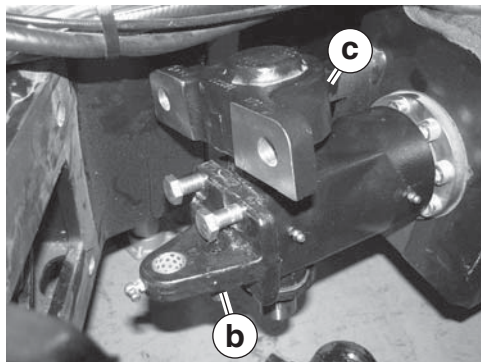

wc\_gr004137

6. Remove the pillow blocks (c).
7. Remove the dowel pin and the castle nut (d).

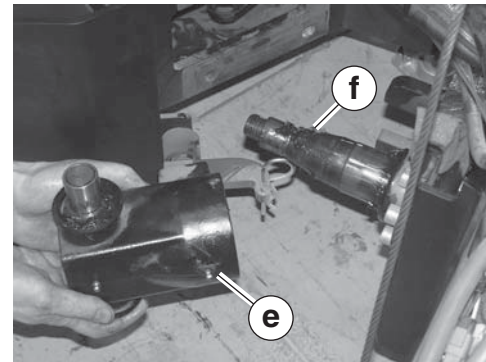
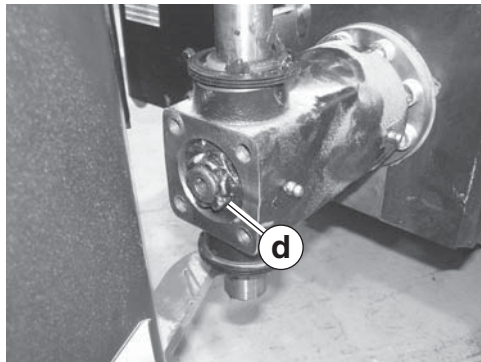

wc\_gr004138

8. Pull the housing (e) from the shaft (f).
  9. Remove the screws that secure the shaft (f) to the front frame and remove the shaft.
- The procedure to remove the articulating joint is now complete.



## 9.6 Installing the Articulating Joint

**Prerequisites** ■ Crane and jacks

**Procedure** Follow the procedure below to install the articulating joint.

1. Support the rear half of the machine with jacks and the front half with an appropriate crane so that the machine will not fall in on itself when the articulating joint is removed.
2. Align the shaft **(a)** so that the dowel hole **(b)** is parallel to the ground. Apply Loctite 243 to the screws **(c)** and secure the shaft to the frame.

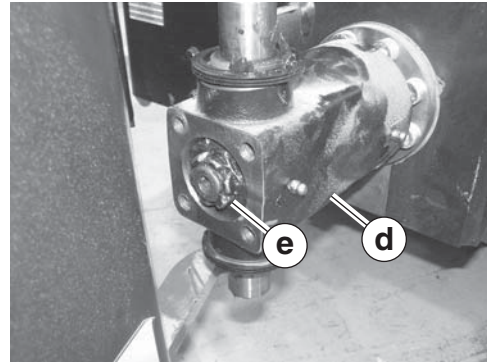
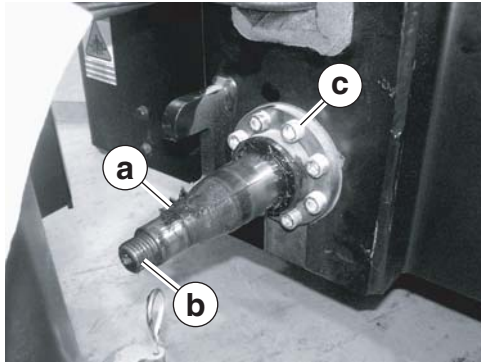

wc\_gr004139

3. Slide the housing **(d)** onto the shaft. Secure the housing with the castle nut **(e)** and the dowel pin.
4. Apply Loctite 243 to the screws **(g)** and secure the pivot plate **(f)** to the housing.

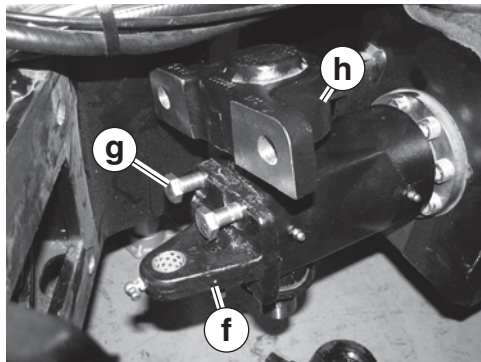

wc\_gr004140

5. Add the pillow blocks **(h)** to the housing.
6. Apply Loctite 243 to the screws **(i)** and secure the pillow blocks to the frame.

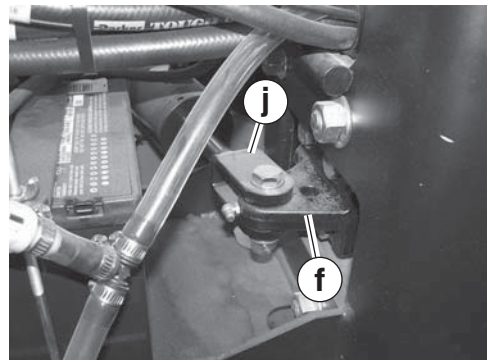
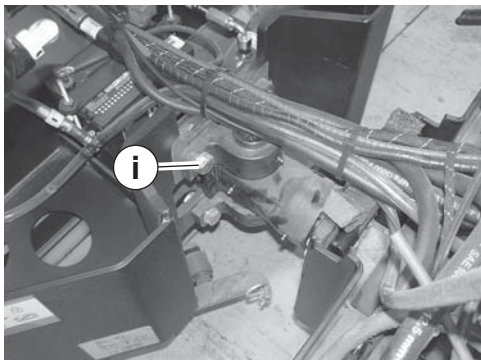

wc\_gr004141

7. Connect the steering cylinder **(j)** to the pivot plate **(f)**.  
The procedure to install the articulating joint is now complete.

## 9.7 Removing the Rear Drum

- Prerequisites**
- Jacks
  - Crane and appropriate sling

**Procedure** Follow the procedure below to remove the rear drum.

1. Chock the front drum.
2. Support the machine with jacks **(a)**.

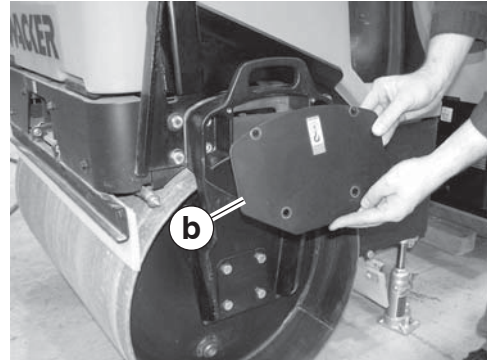
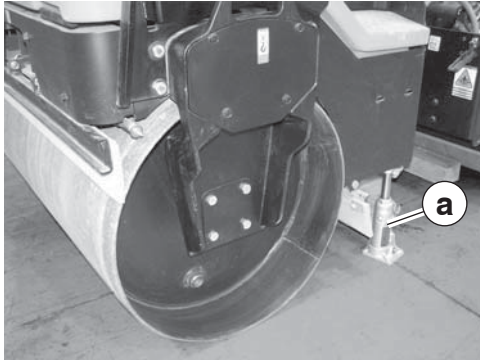

wc\_gr004194

3. Remove the drum support covers **(b)**.
4. Remove the bearing cover **(c)** from the non-drive-motor side of the drum.

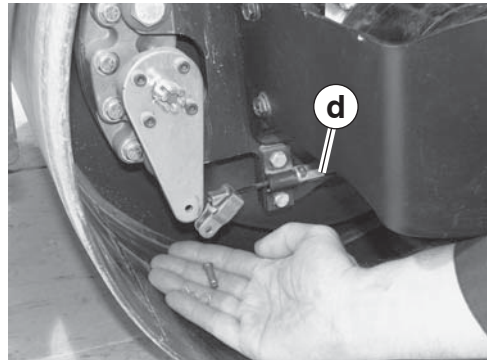
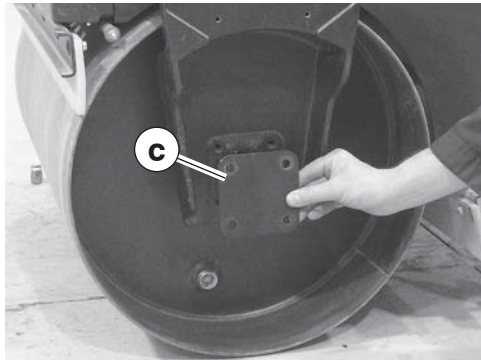

wc\_gr004195

5. Disconnect and remove the brake cable **(d)** from the drum.
6. Remove the metal hydraulic lines **(e)** from the hydraulic hoses. Cap and store the hydraulic hoses in the machine frame.

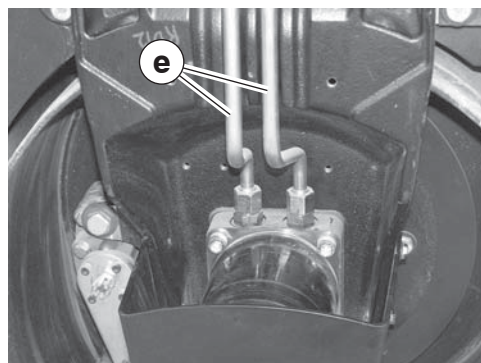

wc\_gr004196

*This procedure continues on the next page.*

*Continued from the previous page.*

7. Support the drum support with an appropriate sling and crane.

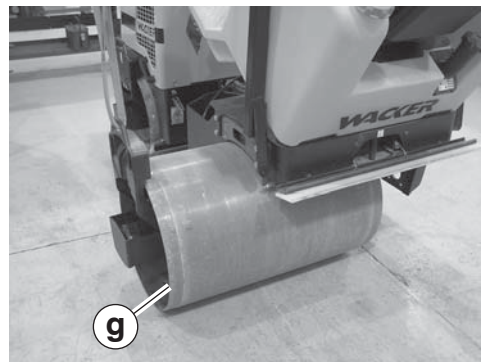
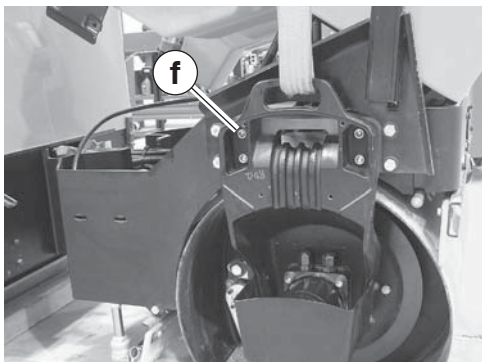

wc\_gr004197

8. Remove the four screws (**f**) that secure the drum support to the machine and slide the drum (**g**) from underneath the machine.

The procedure to remove the front drum is now complete.



## 9.8 Installing the Rear Drum

- Prerequisites**
- Crane and appropriate sling
  - Non-drive-motor side drum support installed

**Procedure** Follow the procedure below to install the rear drum.

1. Chock the front drum.
2. Install the bearing (**h**) onto the shaft of the drum.

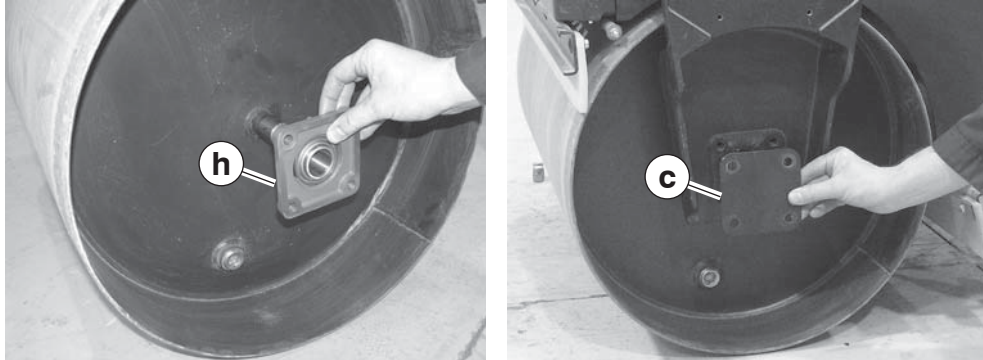

wc\_gr004198

3. Position the drum underneath the machine.
4. Install the bearing cover (**c**) to the non-drive-motor side of the drum.
5. Apply Loctite 243 to screws (**f**) and secure the drum support to the machine. Torque the screws to 79 Nm (58 ft.lbs.).

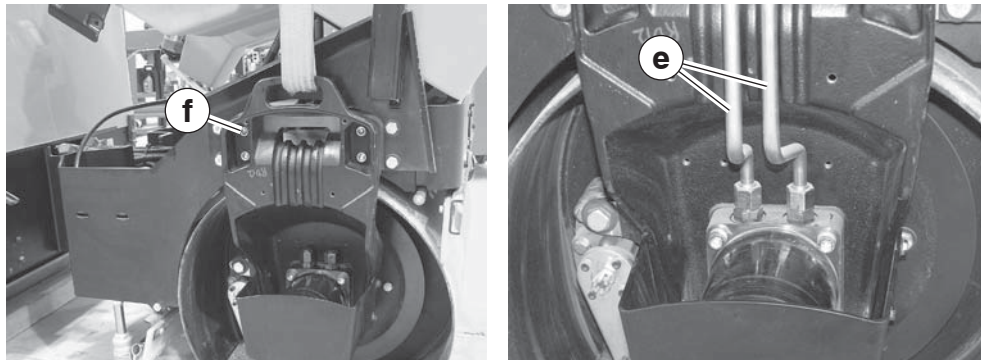

wc\_gr004199

6. Install the metal hydraulic lines (**e**).

*This procedure continues on the next page.*

*Continued from the previous page.*

7. Install the brake cable (**d**) to the drum.

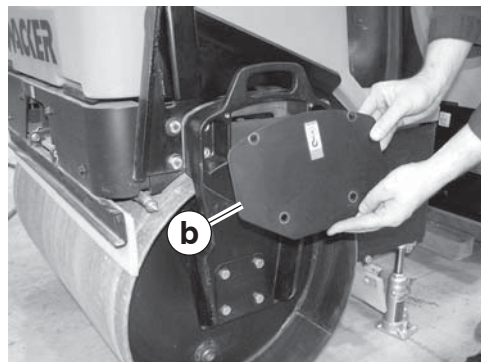
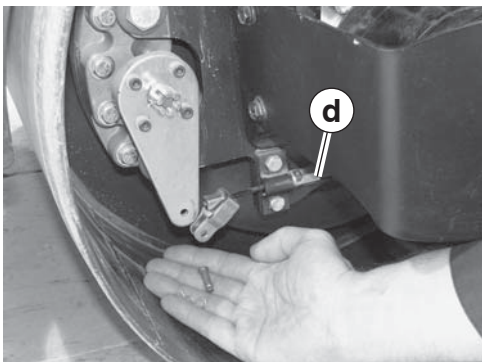

wc\_gr004200

8. Install the drum support covers (**b**).

The procedure to install the rear drum is now complete.

## 9.9 Removing the Brake and Brake Cable

**Prerequisites** ■ Engine off

**Procedure** Follow the procedure below to remove the brake.

1. Chock the drums.
2. Remove the drum support cover (a).

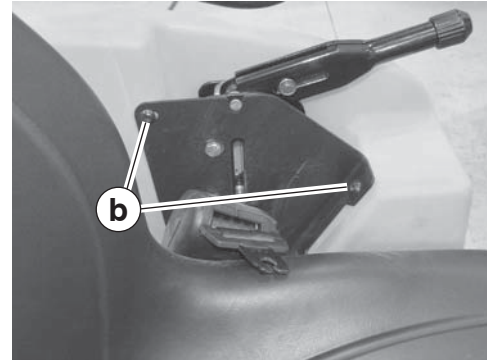
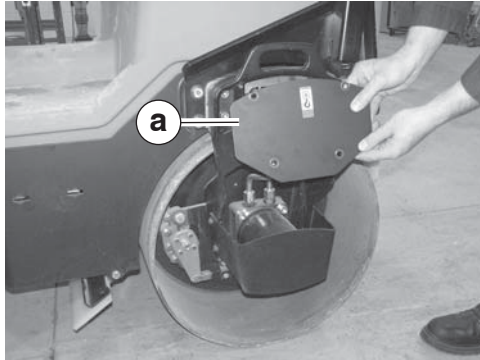

wc\_gr004209

3. Remove the screws (b) that secure the brake lever assembly to the machine.
4. Disconnect the brake cable (c) from the brake and the drum.

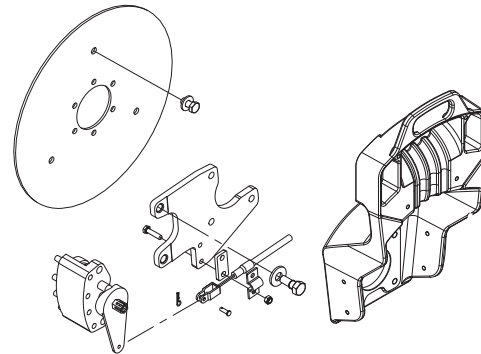
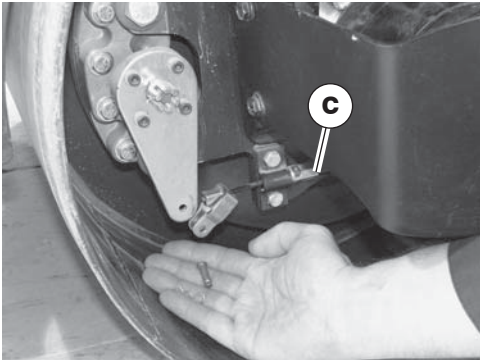

wc\_gr004210

5. Remove the brake lever and brake cable from the machine.
6. Remove the cotter pin (d) and the castle nut (e).

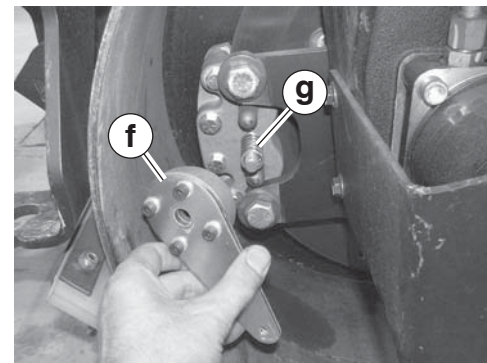
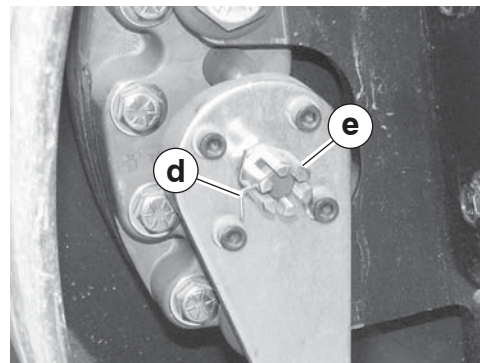

wc\_gr004211

7. Remove the arm (f) and the spring (g).

*This procedure continues on the next page.*

*Continued from the previous page.*

8. Support the rear of the machine with an appropriate crane.

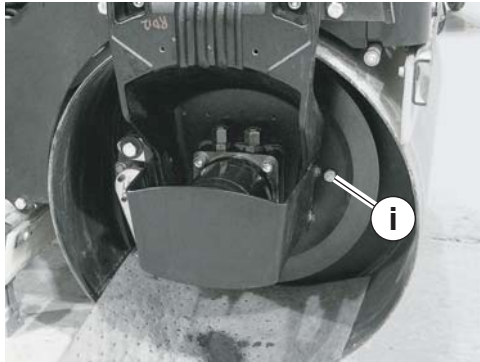

wc\_gr004224

9. Remove the screws **(i)** that secure the drive plate to the shock mounts.
10. Remove the screws **(h)** that secure the brake caliper to the drive plate.

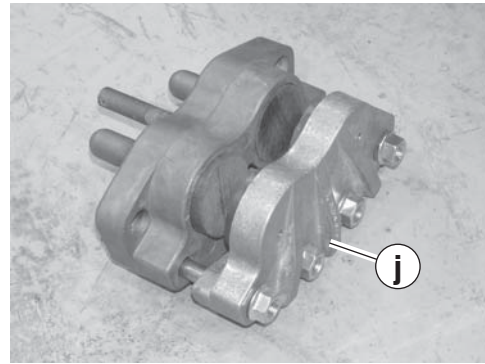
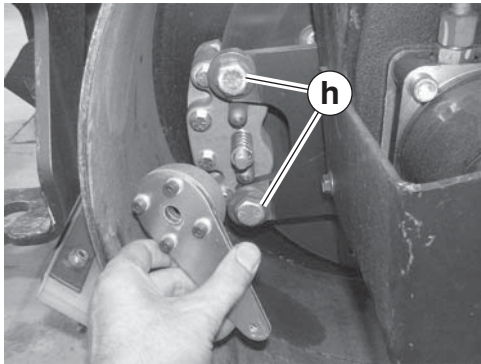

wc\_gr004212

11. Raise the machine (rear drum should remain on the ground) enough to remove the brake caliper **(j)**.

The procedure to remove the brake and brake cable is now complete.



## 9.10 Installing the Brake and Brake Cable

**Prerequisites** ■ Appropriate crane and sling

**Procedure** Follow the procedure below to install the brake.

1. Raise the rear half of the machine approximately 10 cm (4 in.) off the rear drum.
2. Away from the machine, loosely install the four screws (**i**) and nuts that hold the brake caliper (**j**) together; do not tighten the nuts. Slide the brake caliper around the drive plate; then tighten the four screws (**i**) and nuts.

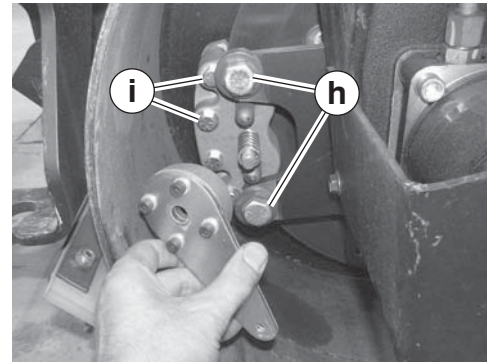
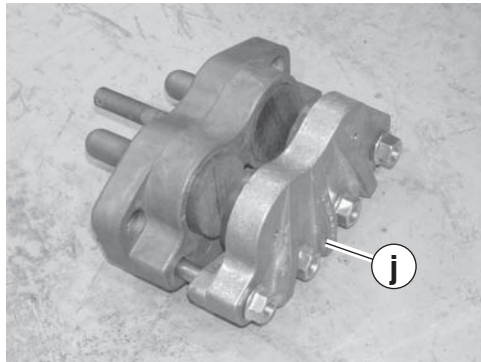

wc\_gr004213

3. Place the brake caliper into position so that when installed the two screws (**h**) will hold the brake caliper. Then, using Loctite 243 or an equivalent on the two screws, secure the two screws to the brake bracket.
4. Lower the rear half of the machine and reconnect the drive plate to the shock mounts. Torque the screws to 76 Nm (56 ft.lbs.).
5. Install the spring (**l**) and the arm (**k**).

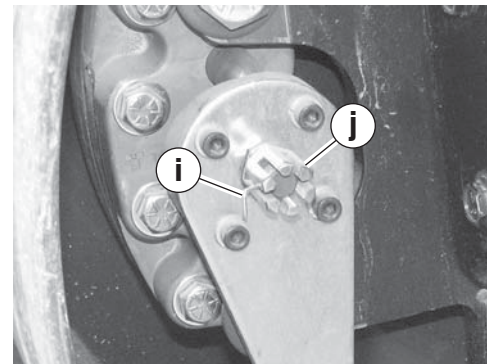
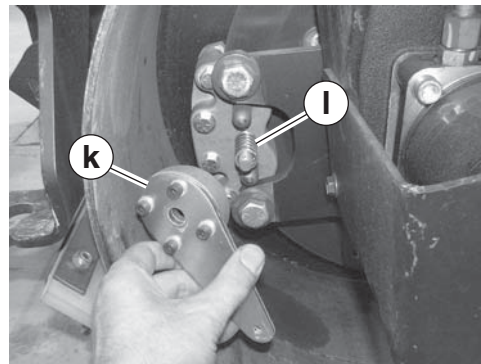

wc\_gr004214

6. Install the castle nut (**j**) and the cotter pin (**i**).

*This procedure continues on the next page.*

*Continued from the previous page.*

7. Install the two screws **(g)**, nuts, and bracket which secure the cable **(h)** to the machine.

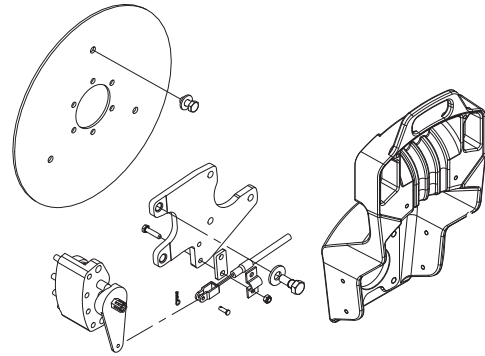
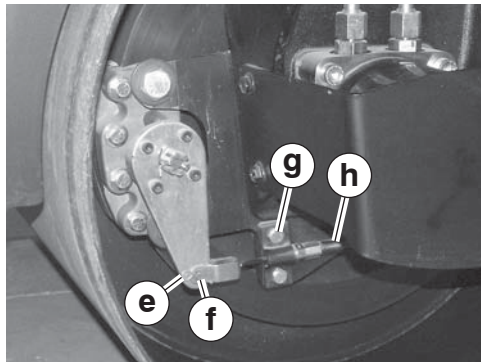

wc\_gr004215

8. Install the hitch pin **(e)** and the clevis pin **(f)**.
9. Run the cable through the drum support and connect it to the brake handle **(b)**.

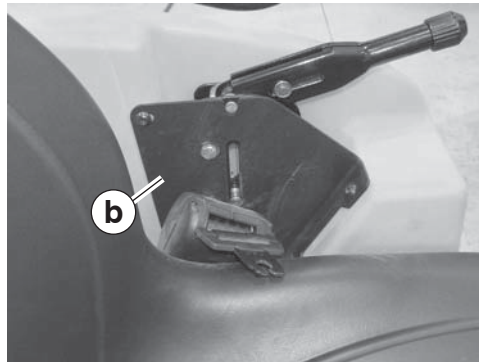
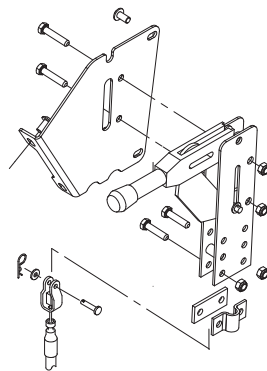

wc\_gr004216

10. Secure the brake handle **(b)** to the machine.
11. Install the drum support cover.

The procedure to install the brake and brake cable is now complete.

## 9.11 Removing Rear Drive Motor

**Prerequisites** ■ Rear drum removed

**Procedure** Follow the procedure below to remove the rear drive motor.

1. Rotate the drive motor assembly as needed to reach the three screws (a) which mount the drive plate to the drum. Remove the three screws. **Note:** *If the motor assembly is difficult to turn, loosen the caps on the hydraulic lines leading to the motor to allow the release of any hydraulic pressure. These are the caps connected to the lines while removing the drum.*

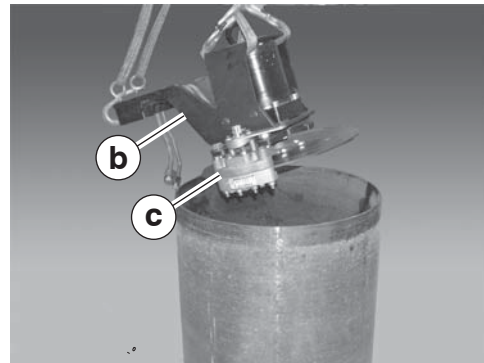
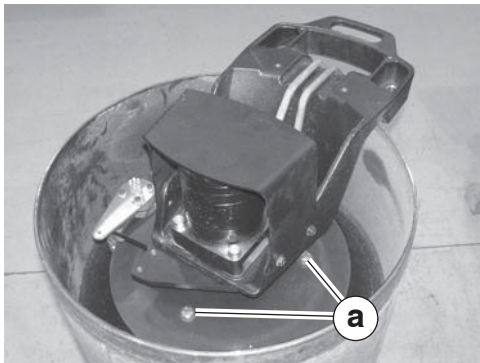

wc\_gr004217

2. Using an appropriate crane, lift the drum support (b), with the drive motor still attached, up and off of the drum.
3. Remove the brake assembly (c). See section *Removing the Brake and Brake Cable*.
4. Remove the nut (d).

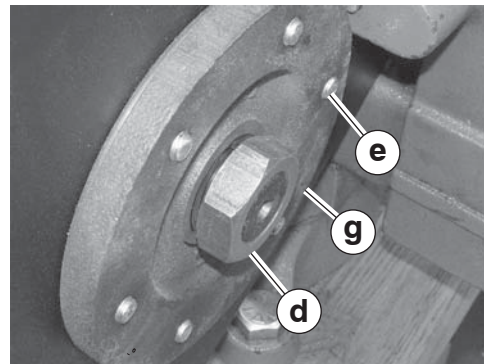
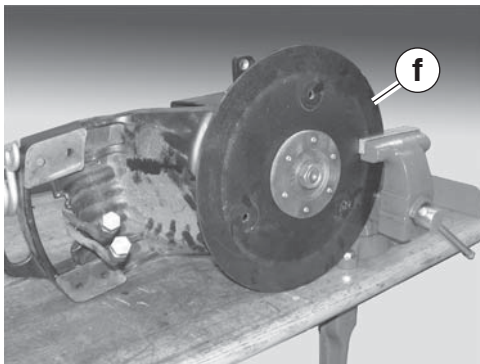

wc\_gr004218

5. Remove the screws (e) that secure the drive plate (f) to the hub (g).

*This procedure continues on the next page.*

*Continued from the previous page.*

6. Remove the motor guard (**g**).

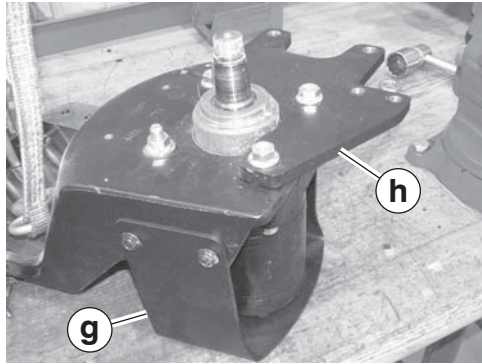

wc\_gr004219

7. Remove the brake bracket (**h**).
8. Remove the drive motor (**i**) from the drum support.

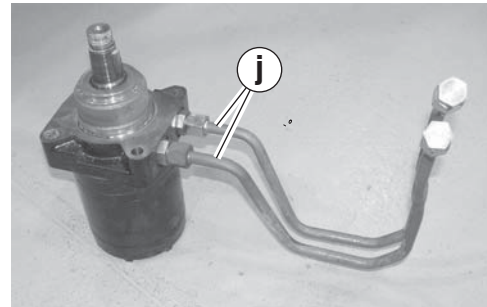
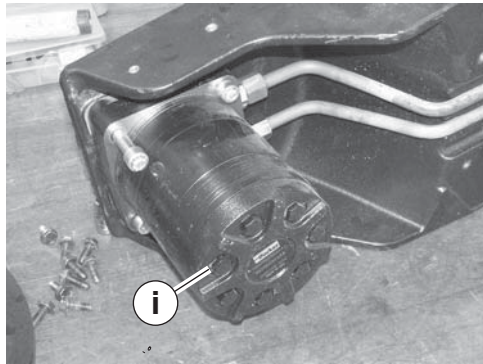

wc\_gr004220

9. Remove the hydraulic lines (**j**) and fittings from the drive motor if not already removed.

The procedure to remove the rear drive motor is now complete.



## 9.12 Installing the Rear Drive Motor

**Prerequisites** ■ Rear drum removed

**Procedure** Follow the procedure below to install the rear drive motor.

1. Connect the hydraulic lines (**j**) and fittings to the drive motor.

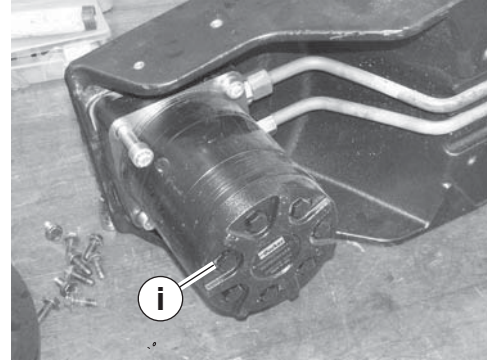
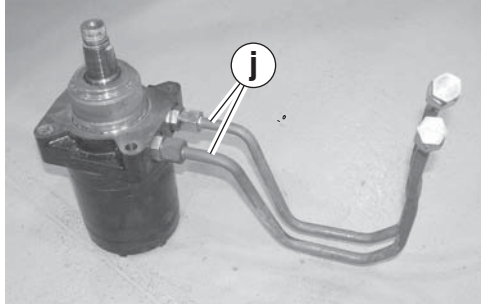

wc\_gr004221

2. Apply Loctite 243 to the screws and secure the drive motor (**i**) to the drum support. Torque the screws to 76 Nm (56 ft.lbs.).
3. Install the brake bracket (**h**).

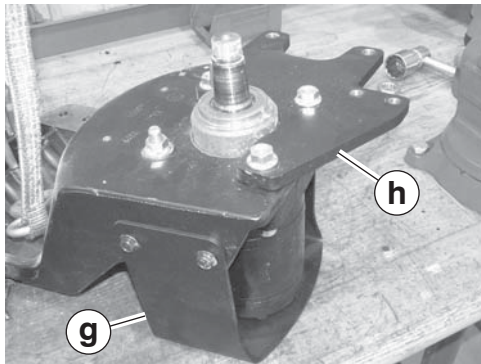

wc\_gr004219

4. Install the motor guard (**g**).
5. Install the drive plate (**f**) to the hub (**g**) with the screws (**e**). Torque the screws to 44 Nm (32 ft.lbs.).

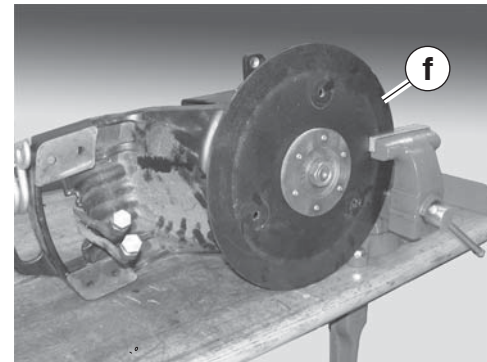
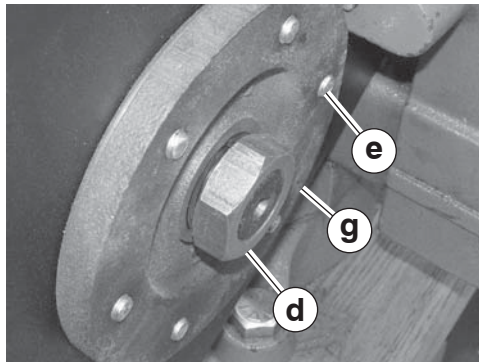

wc\_gr004222

6. Install the key on the drive motor. Place the hub/drive plate assembly onto the drive motor. Using Loctite 243 on the nut (**d**), secure the hub/drive plate assembly to the drive motor. Torque the nut to 410 Nm (300 ft.lbs.).

*This procedure continues on the next page.*

Continued from the previous page.

7. Install the brake assembly (c). See section *Installing the Brake*.

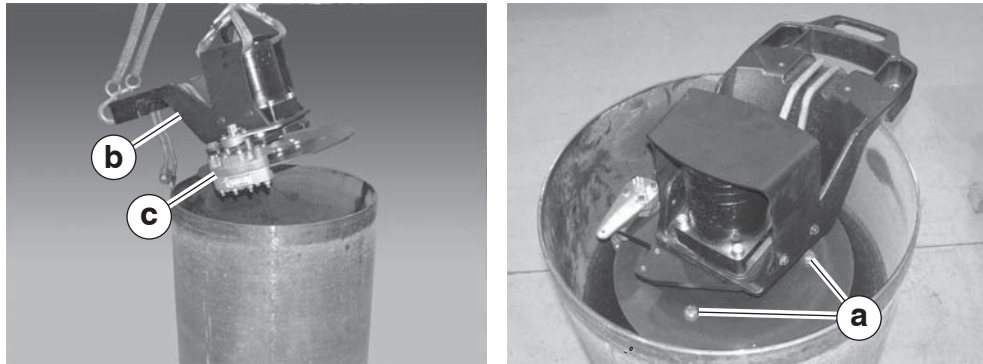

wc\_gr004223

8. Using an appropriate crane, position the drum support/drive motor assembly (b) on the drum. Using Loctite 243 on the three screws (a), secure the drive motor assembly to the drum. Torque the screws to 76 Nm (56 ft.lbs.).

The procedure to install the rear drive motor is now complete.

### 9.13 Removing the Front Drum

- Prerequisites**
- Crane and appropriate sling
  - Jacks

**Procedure** Follow the procedure below to remove the front drum.

1. Support the front half of machine with jacks (a).

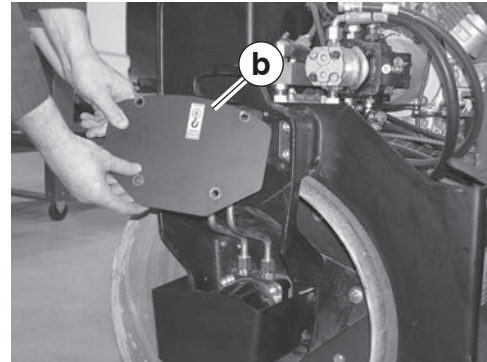
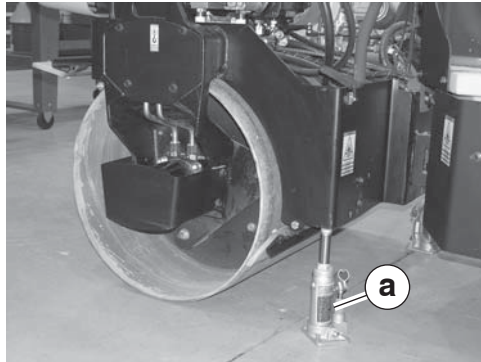

wc\_gr004145

2. Remove the drum support covers (b) from each side of the machine.
3. Remove the drive motor guard (c).

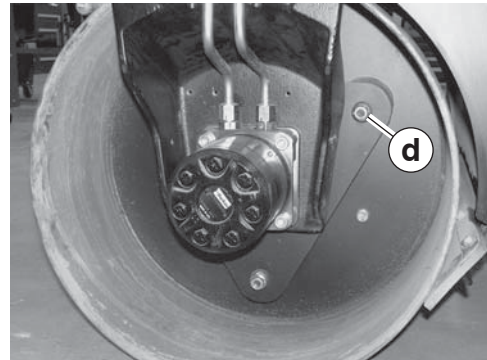
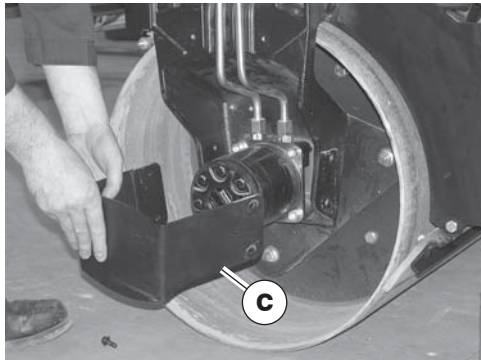

wc\_gr004146

4. Remove the screws (d) that secure the drive plate to the drum.
5. Disconnect and plug the hydraulic lines (e) from the drive motor.

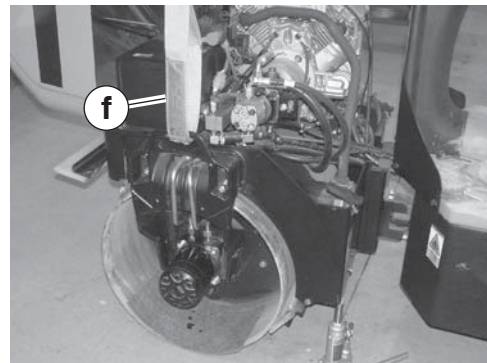
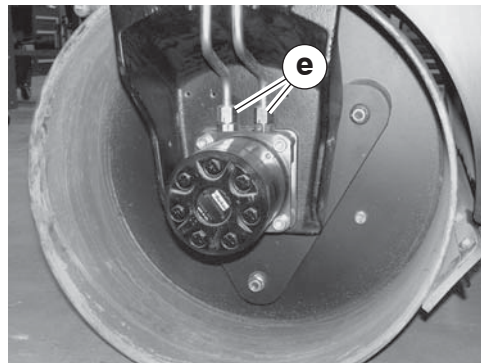

wc\_gr004147

6. Secure the drum support with an appropriate sling (f) and crane.

*This procedure continues on the next page.*



*Continued from the previous page.*

7. Remove the screws **(g)** that secure the drum support to the machine.

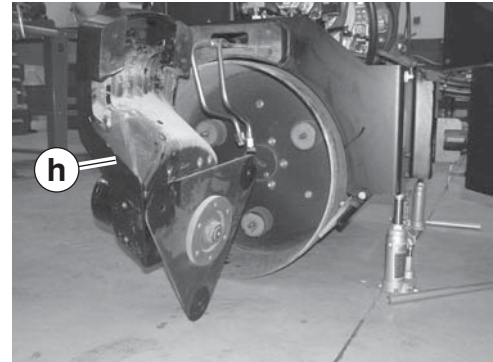
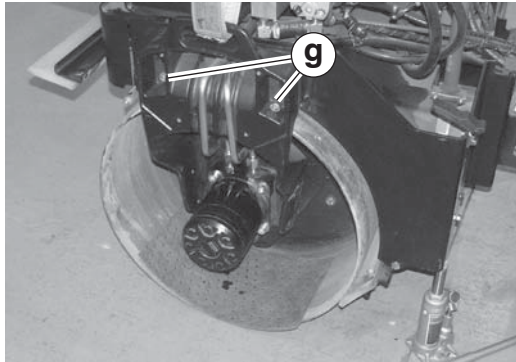

wc\_gr004148

8. Lift the drum support **(h)** and drive motor from the machine.
9. Disconnect and plug the hydraulic lines **(i)** from the exciter motor. Then, remove the exciter motor.

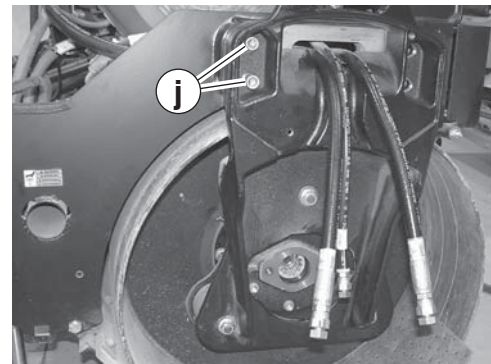
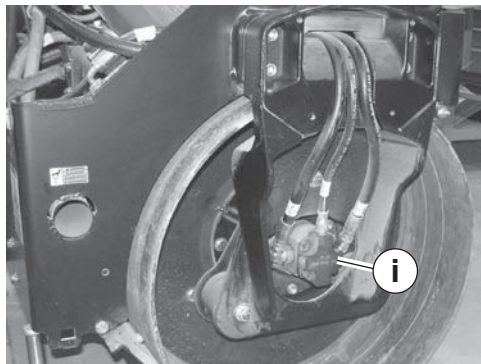

wc\_gr004149

10. Secure the drum support with an appropriate sling and crane.
11. Remove the screws **(j)** that secure the drum support to the machine and pull the drum from underneath the machine.

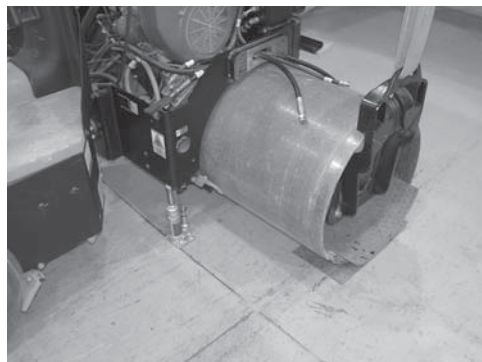

wc\_gr004150

The procedure to remove the front drum is now complete.

## 9.14 Installing the Front Drum

- Prerequisites**
- Crane and appropriate sling
  - Jacks

**Procedure** Follow the procedure below to install the front drum.

1. Slide the drum into position underneath the machine.

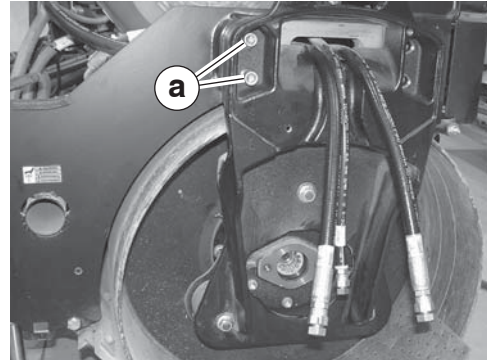
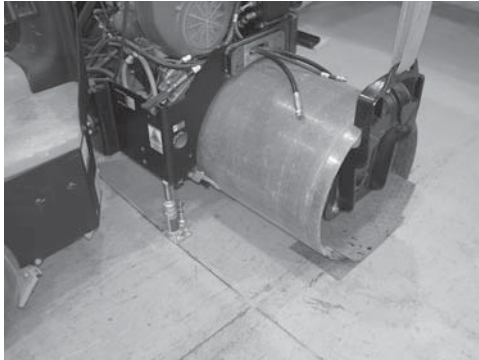

wc\_gr004151

2. Apply Loctite 243 to the screws (**a**) and secure the exciter-motor-side drum support to the frame. Torque the screws to 79 Nm (58 ft.lbs.).
3. Reconnect the hydraulic lines (**b**) to the exciter motor. Apply Loctite 243 to the screws and secure the exciter motor (**c**) to the drum support.

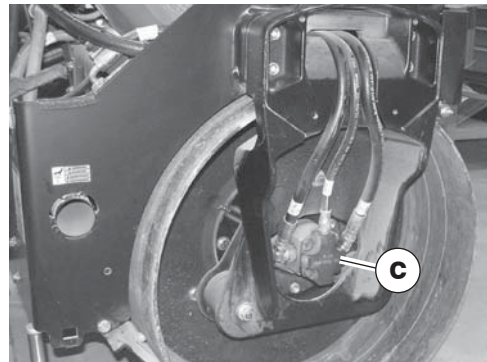
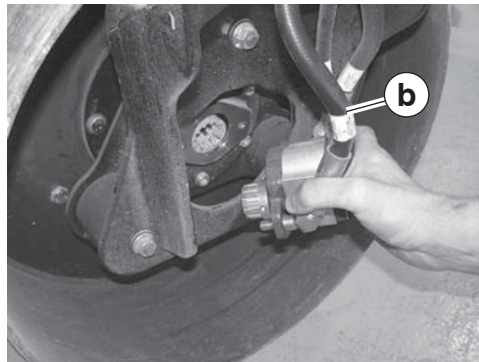

wc\_gr004152

4. Apply Loctite 243 to the screws and secure the exciter motor (**c**) to the drum support. Torque the screws to 44 Nm (32 ft.lbs.).

*This procedure continues on the next page.*

*Continued from the previous page.*

5. Position the drum so that the drive plate can be installed to the three shock mounts (**d**). Install the drive plate to the drum. Torque the nuts (**e**) to 76 Nm (56 ft.lbs.).

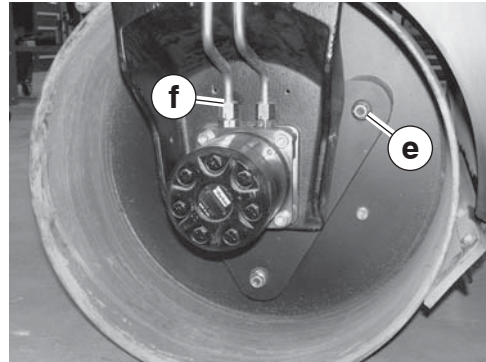
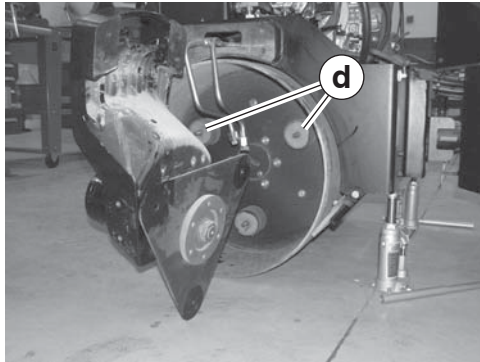

wc\_gr004153

6. Reconnect the hydraulic lines (**f**) to the drive motor.
7. Apply Loctite 243 to screws (**g**) and secure the drive-motor-side drum support to the frame. Torque the screws to 79 Nm (58 ft.lbs.).

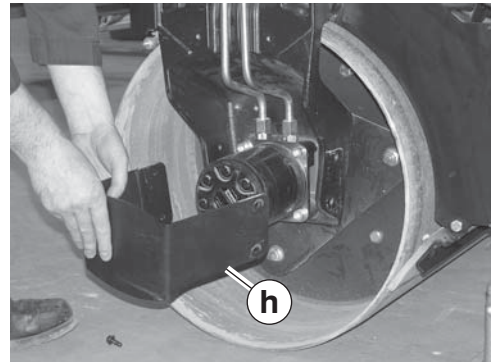
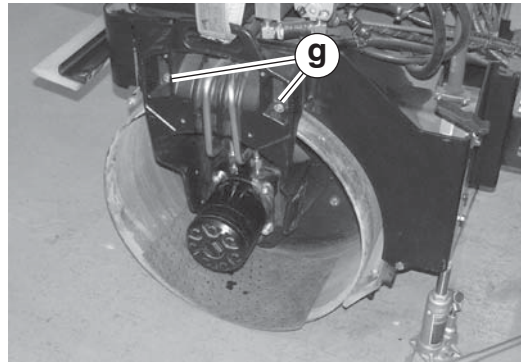

wc\_gr004154

8. Install the drive motor guard (**h**).
9. Install the drum support covers (**i**) to each side of the machine.

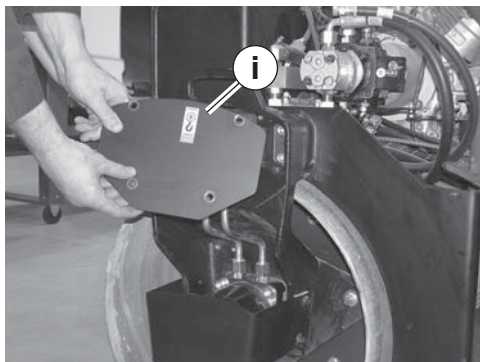

wc\_gr004155

The procedure to install the front drum is now complete.



## 9.15 Removing the Front Drive Motor

- Prerequisites**
- Front drum removed
  - Puller

**Procedure** Follow the procedure below to remove the front drive motor.

1. Remove the front drum. See section *Removing the Front Drum*.
2. Remove the nut **(a)** that secures the hub **(b)** to the drive motor.

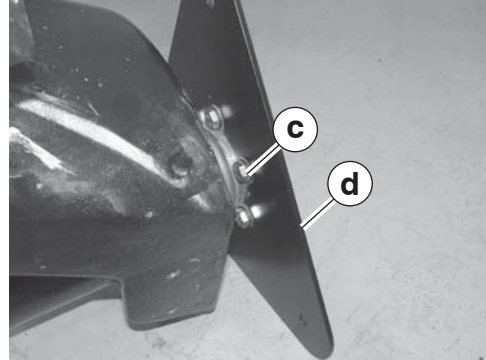
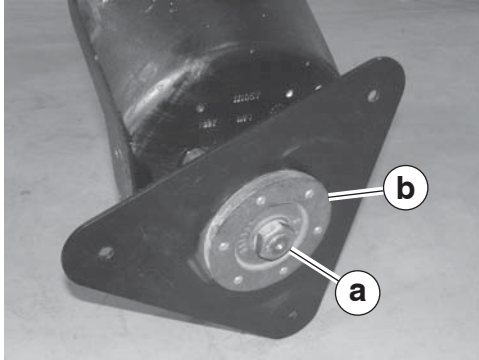

wc\_gr004157

3. Remove the screws **(c)** that secure the drive plate **(d)** to the hub.
4. Slide the drive plate **(d)** off the hub.

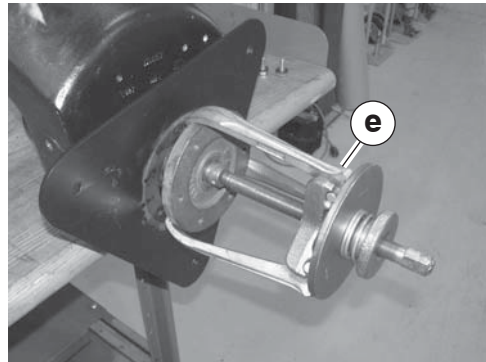
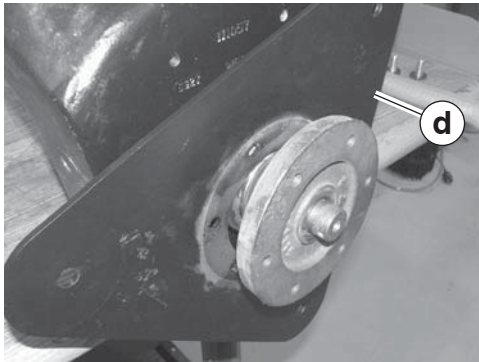

wc\_gr004156

5. Pull the hub from the drive motor using a puller **(e)**.
6. Remove the screws that secure the drive motor **(f)** to the drum support **(g)** and remove the drive motor.

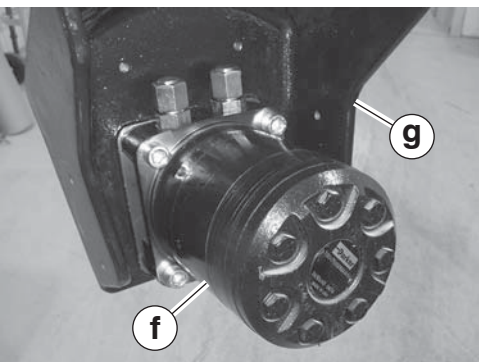

wc\_gr004158

The procedure to remove the front drive motor is now complete.



## 9.16 Installing the Front Drive Motor

**Prerequisites** ■ Front drum removed

**Procedure** Follow the procedure below to install the front drive motor.

1. Apply Loctite 243 to the screws and install the drive motor **(a)** to the drum support **(b)**. Torque the the screws to 76 Nm (56 ft.lbs.).

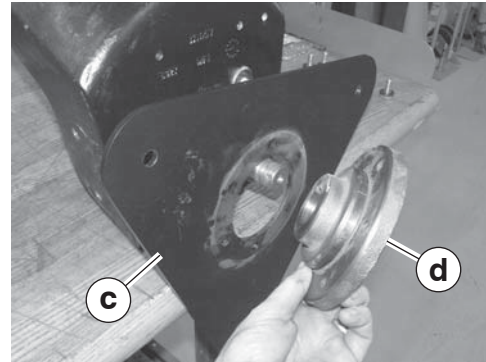
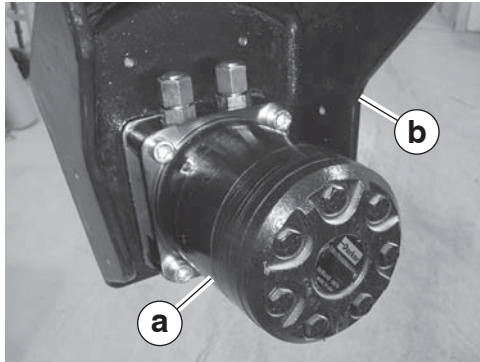

wc\_gr004159

2. Position the drive plate **(c)** and the hub **(d)** onto the shaft of the drive motor.
3. Apply Loctite 243 to screws **(e)** and secure the drive plate **(c)** to the hub. Torque the screws to 44 Nm (32 ft.lbs.).

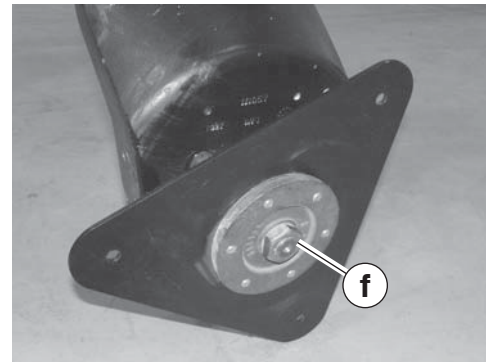
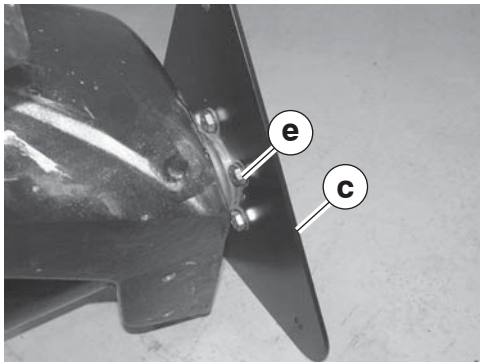

wc\_gr004160

4. Apply Loctite 243 to the nut **(f)** and secure the hub to the drive motor. Torque the nut to 407 Nm (300 ft.lbs.).

The procedure to install the front drive motor is now complete.

## 9.17 Removing the Exciter

**Prerequisites** ■ Front drum removed

**Procedure** Follow the procedure below to remove the exciter.

1. Remove the screws **(a)** that secure the drum support **(b)** to the shock mounts and remove the drum support.

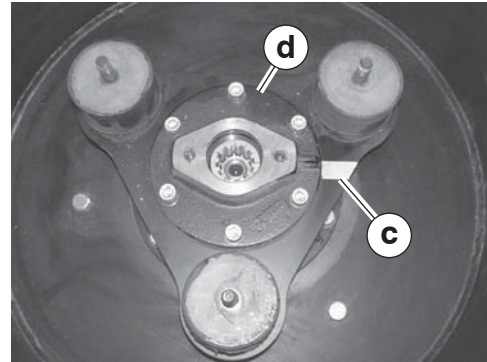
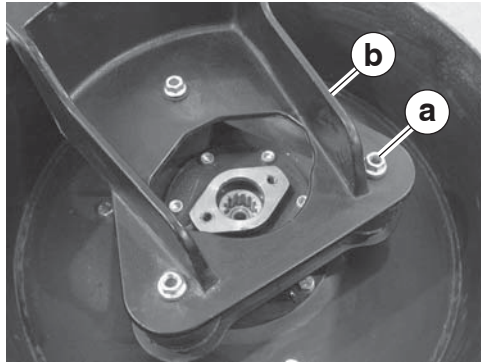

wc\_gr004161

2. Mark **(c)** the position of the motor mount **(d)**.
3. Remove the motor mount **(d)**.

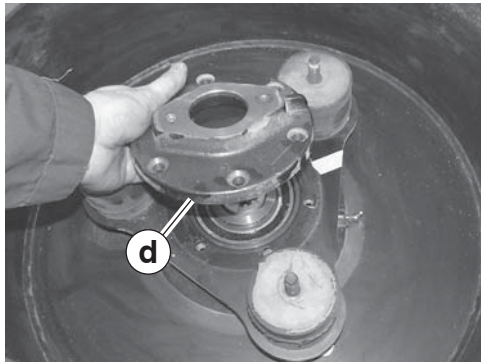

wc\_gr004162

4. Remove the shock mount plate **(e)**.
5. Mark the position **(f)** of the bearing housing.

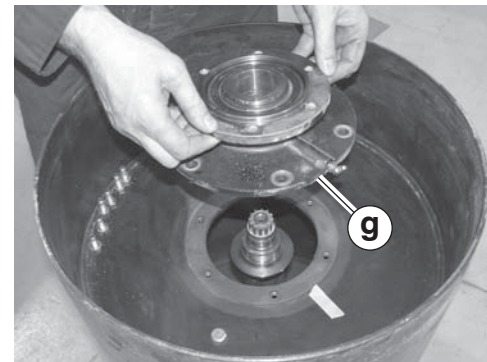
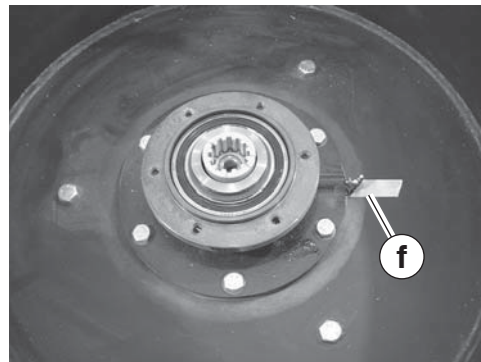

wc\_gr004163

6. Remove the bearing housing **(g)**.

*This procedure continues on the next page.*

*Continued from the previous page.*

7. Pull the exciter (**h**) up and out of the drum.

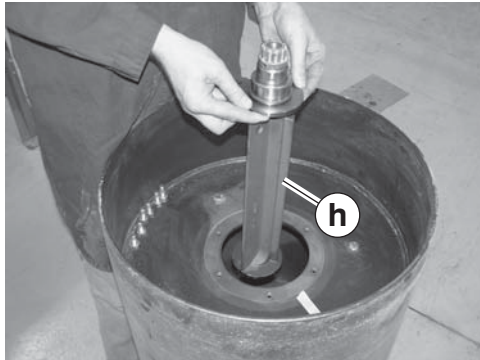

wc\_gr004164

The procedure to remove the exciter is now complete.

## 9.18 Installing the Exciter

- Prerequisites**
- Front drum removed
  - Drive-motor-side exciter bearing installed

**Procedure** Follow the procedure below to install the exciter.

1. Install the key and the gear (a) of the exciter motor coupling onto the exciter. Secure the gear to the exciter with the set screw.

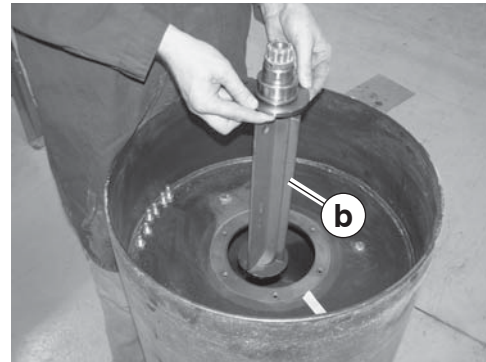
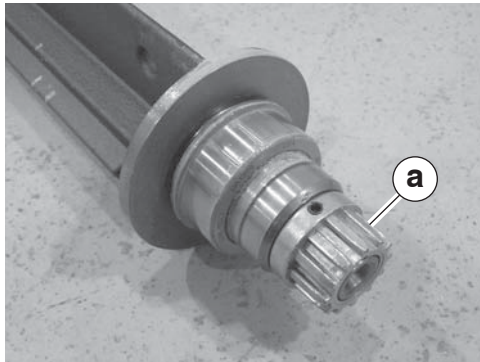

wc\_gr004165

2. Slide the exciter (b) through the drum and into the drive-motor-side bearing race.
3. Temporarily install the exciter-side drum hub (c) onto the drum using three screws.

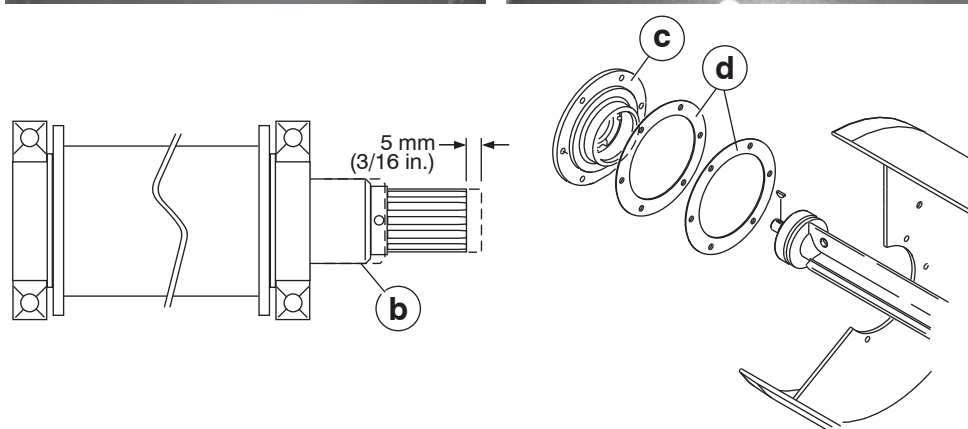
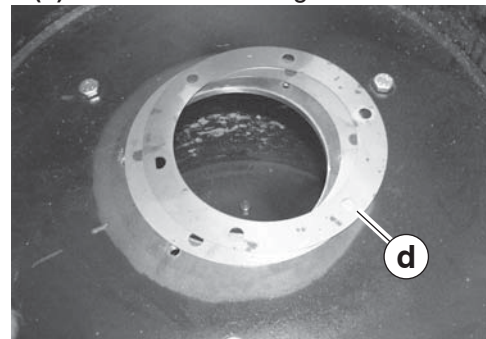
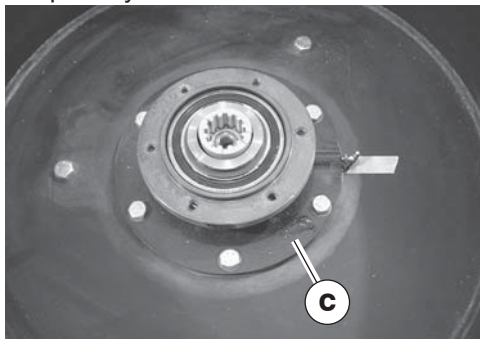

wc\_gr004166

4. Check the exciter for end-play. To do so, grab the exciter (b) with a needle-nosed pliers and pull and push it back and forth inside the drum. There needs to be  $5 \pm 1$  mm ( $3/16 \pm 1/16$  in.) of end-play for correct performance. If the correct amount of end-play is not found, remove the drum hub and install shims (d) as needed to obtain the correct amount of end-play. Then, using Loctite 243 on the six screws, secure the drum hub to the drum. Torque the screws to 49 Nm (36 ft.lbs.).

*This procedure continues on the next page.*

*Continued from the previous page.*

5. Using Loctite 243 on the six screws **(e)**, secure the bearing cover **(f)** and the shock mount plate **(g)** to the drum support. Torque the screws to 50 Nm (36 ft.lbs.).

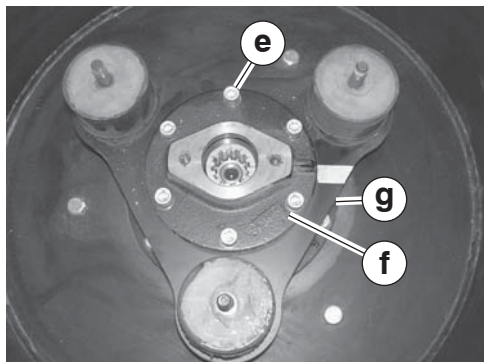

wc\_gr004167

The procedure to install the exciter is now complete.



## 9.19 Disassembling the Exciter Bearings

- Prerequisites**
- Front drum removed
  - Puller

**Procedure** On the exciter side of the drum, two bearings and their flanges make up the drum hub (d). Follow the procedure below to disassemble the exciter bearings.

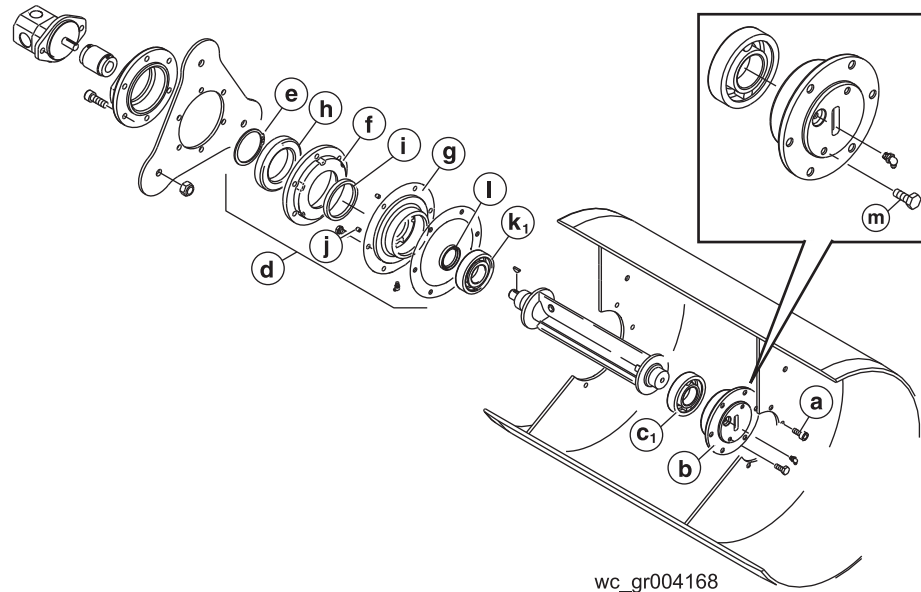

1. Remove the retaining ring (e).

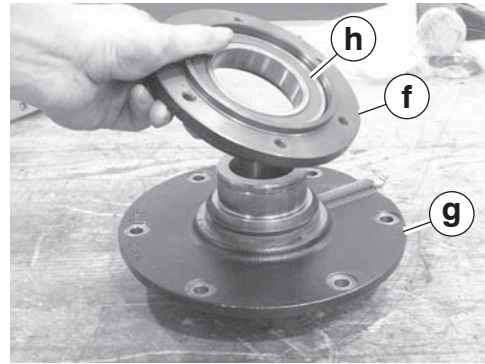
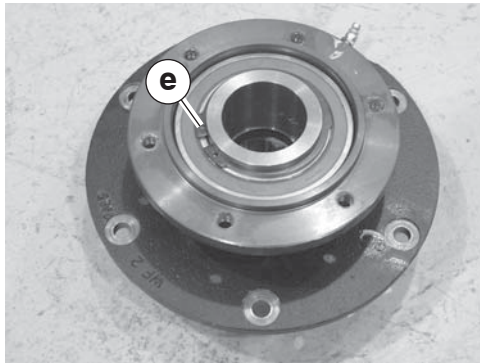

wc\_gr004169

2. Use a puller to pull the smaller bearing flange (f) and bearing (h) from the shaft of the larger bearing flange (g). Then, use a press to press out the bearing (h) from the smaller bearing flange.

*This procedure continues on the next page.*

Continued from the previous page.

3. On the larger bearing flange, remove the outer seal (i) and use the two set screws (j) to push the outer bearing race (k1) from the larger bearing flange.

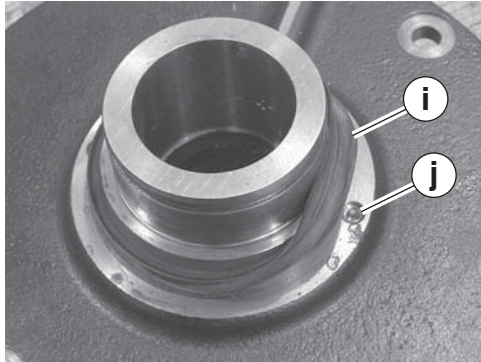

wc\_gr004170

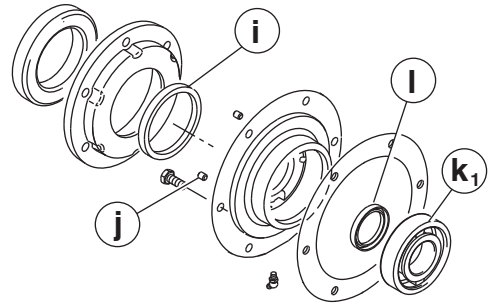

wc\_gr004244

4. Remove the inner seal (l) if necessary.

In order to remove the drive-motor-side exciter bearing, the drive motor and the left-side drum support must be removed. See section *Removing Front Drive Motor*.

5. Remove the six screws (a) which secure the drive-motor-side bearing flange (b) and remove the bearing flange. **Note:** The drive-motor-side bearing flange is removed from inside the drum.

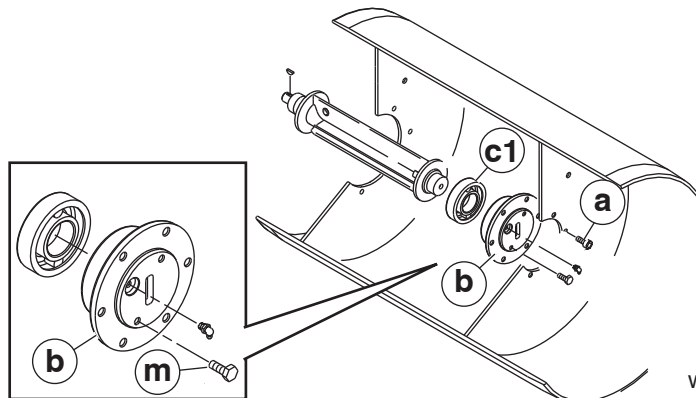

wc\_gr004171

6. Remove the two screws (m) from the drive-motor-side bearing flange (b). In their place, insert two M8 pusher screws. Use the pusher screws to push the outer bearing race (c1) from the drive-motor-side bearing flange (b).
7. Use a puller to remove the inner bearing races (c2 and k2) from the exciter.

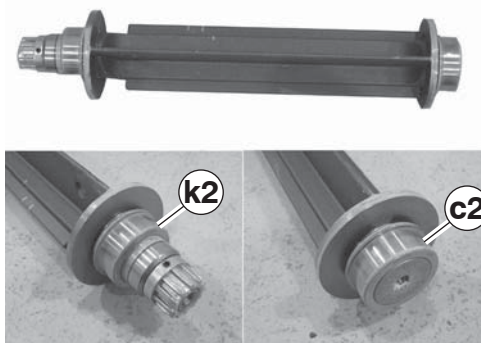

wc\_gr004172

The procedure to disassemble the exciter bearings is now complete.



## 9.20 Assembling the Exciter Bearings

**Prerequisites** ■ Front drum removed

**Procedure** Follow the procedure below to assemble the exciter bearings.

1. Press new inner bearing races (**c2** and **k2**) onto the exciter.

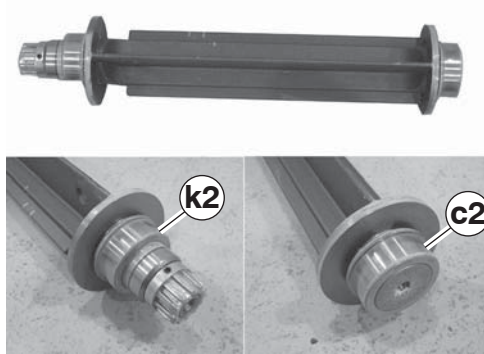

wc\_gr004172

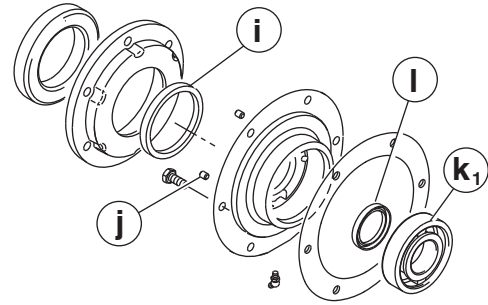

wc\_gr004244

2. Install the outer bearing race into the drive-motor-side bearing flange (**b**).

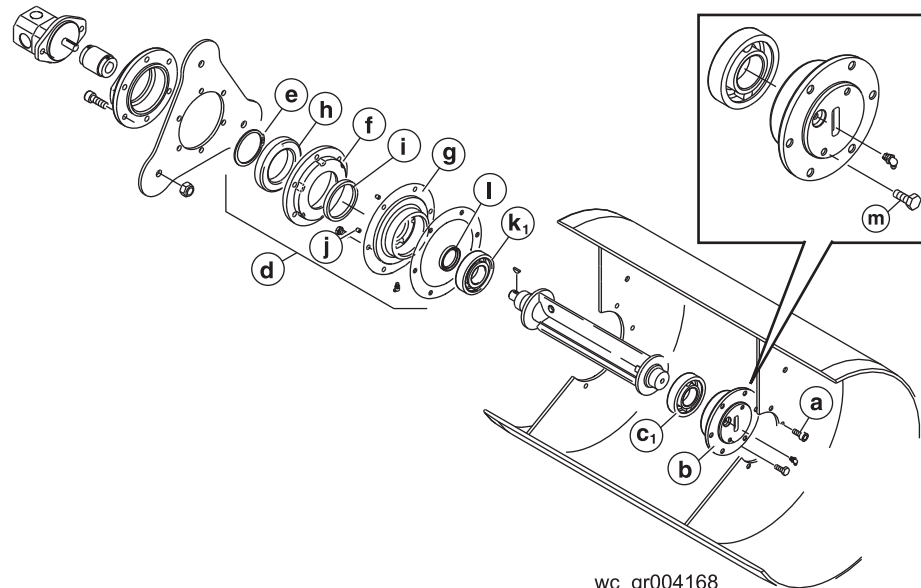

wc\_gr004168

3. Using Loctite 234 on the six screws (**a**), secure the drive-motor-side bearing flange to the drum. Torque the screws to 49 Nm (36 ft.lbs.).

*This procedure continues on the next page.*

*Continued from the previous page.*

4. Be sure set the screws (**j**) are recessed on the larger bearing flange (**g**). Install a new inner seal (**l**). Lightly grease the outer bearing race and press it into the larger bearing flange.

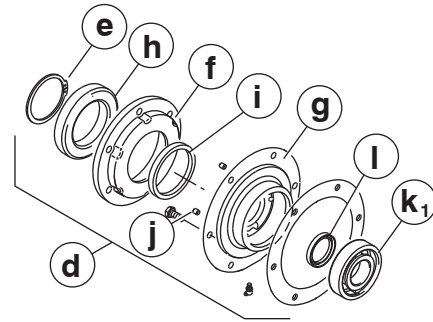
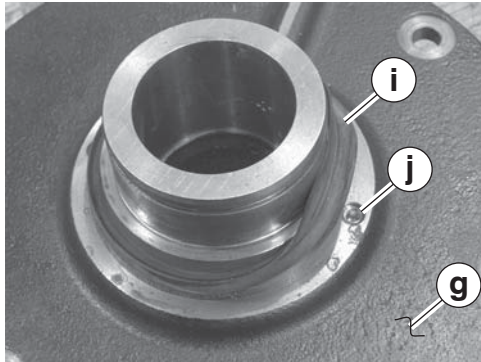

wc\_gr004181

5. Install a new outer seal (**i**) on the shaft of the larger bearing flange.
6. Press the bearing (**h**) into the smaller bearing flange (**f**).

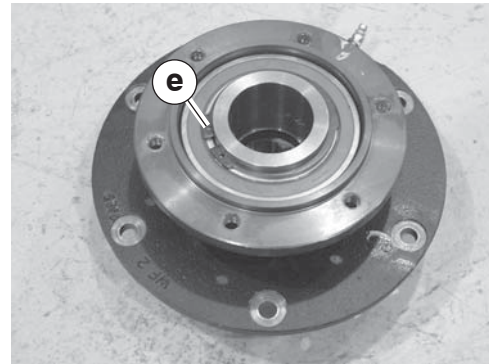
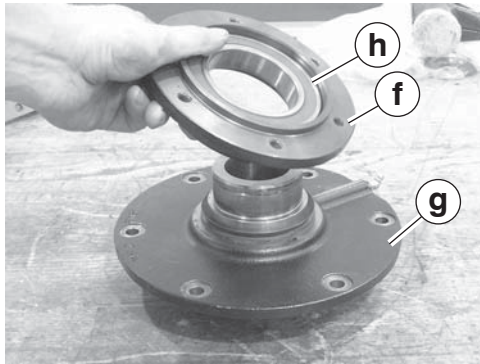

wc\_gr004182

7. Press the two bearing flanges together to create the drum hub.
8. Install the retaining ring (**e**).
9. Lubricate the exciter bearings with wheel bearing grease Mobil XHP222 or equivalent.

The procedure to assemble the exciter bearings is now complete.

## 9.21 Removing the Control Cable and Control Lever

- Prerequisites**
- Machine OFF and engine cool
  - Seat platform in raised position

**Procedure** Follow the procedure below to remove the control cable and the control lever.



**CAUTION!** Burn hazard. The engine exhaust pipes are extremely hot while the engine is running and for a period of time after the engine has shut down.

- ▶ Allow the exhaust pipes to cool before performing this procedure.

1. Disconnect the control cable **(a)** from the drive pump.

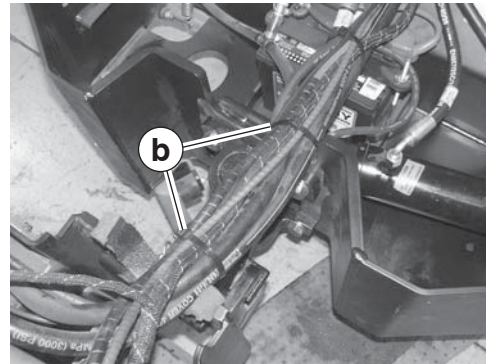
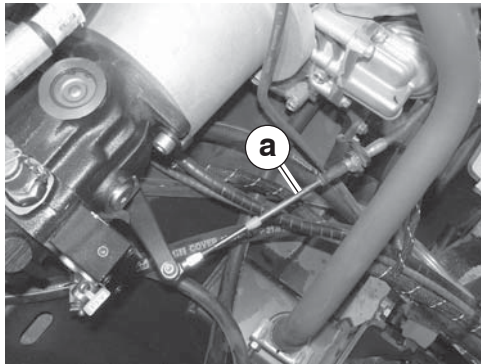

wc\_gr004189

2. Cut the wire ties **(b)** that secure the hoses, wires, and cables. Maneuver the cable around the engine so that it is free up to the control lever.
3. Disconnect the wiring at the connector **(c)**.

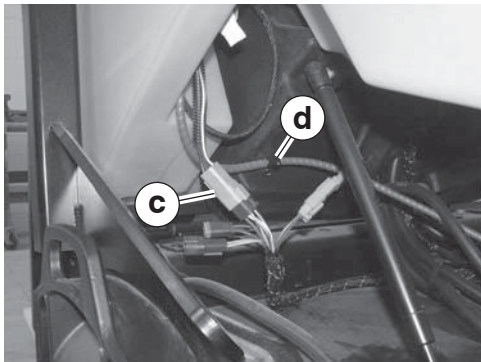

wc\_gr004190

4. Remove the cable clamp **(d)**.

*This procedure continues on the next page.*

*Continued from the previous page.*

5. Remove the screws **(e)** that secure the control lever assembly **(f)** and remove the control lever assembly from the machine.

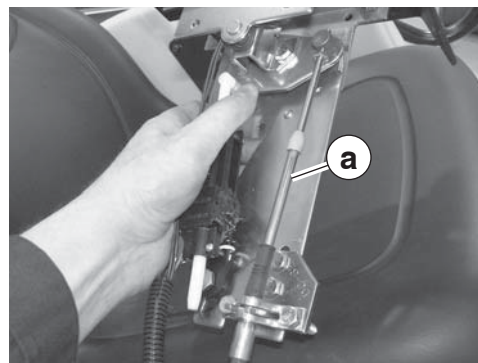
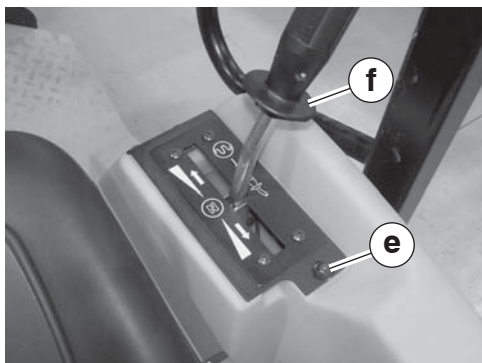

wc\_gr004191

6. Disconnect the control cable **(a)** from the control lever assembly.

The procedure to remove the control cable and the control lever is now complete.



## 9.22 Installing the Control Cable and Control Lever

**Prerequisites** ■ Seat platform in raised position

**Procedure** Follow the procedure below to install the control cable and the control lever.

1. Check that the clamp bracket is positioned correctly. It should be positioned with the screws (**g**) in the first and third holes of the control lever assembly (**f**).

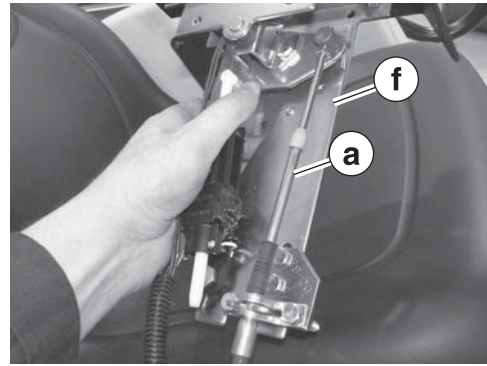
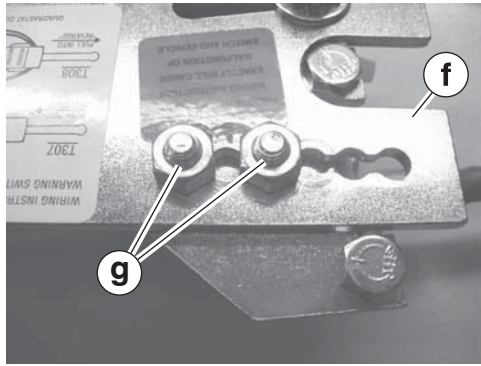

wc\_gr005416

2. Connect the control cable (**a**) to the control lever assembly (**f**).
3. Install control lever assembly (**f**) with the screws (**e**)

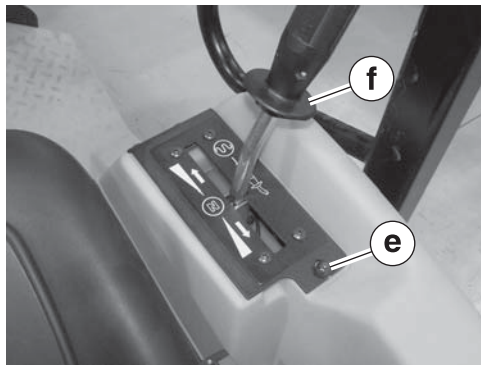

wc\_gr005417

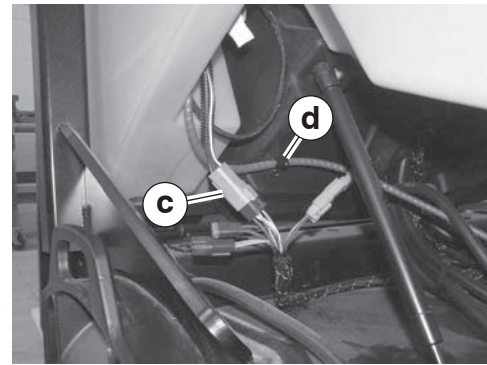

wc\_gr004190

4. Install the cable clamp (**d**).
5. Connect the wiring at the connector (**c**).
6. Secure the hoses, wires, and cables with new wire ties (**b**).

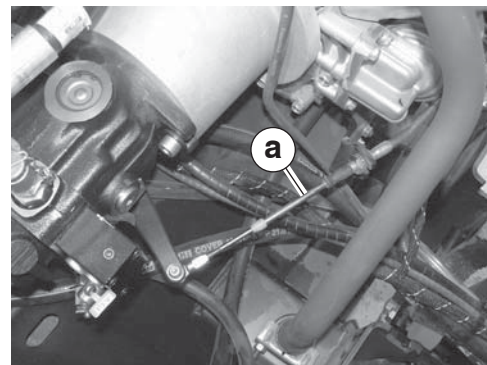
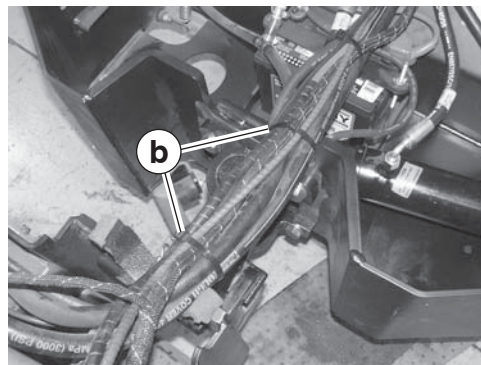

wc\_gr004193

7. Maneuver the control cable (**a**) around the engine and connect it to the drive pump. The procedure to install the control cable and the control lever is now complete.

## 9.23 Removing the Exciter Pump

- Prerequisites**
- Machine OFF and engine cool
  - Hose plug

**Procedure** Follow the procedure below to remove the exciter pump.



**CAUTION!** Burn hazard. The engine exhaust pipes are extremely hot while the engine is running and for a period of time after the engine has shut down.

- ▶ Allow the exhaust pipes to cool before performing this procedure.

1. Place a plastic sheet and a container under the machine to collect any liquid which drains off. Dispose of this liquid in accordance with environmental protection legislation.
2. Disconnect and cap the outgoing hydraulic line (a).

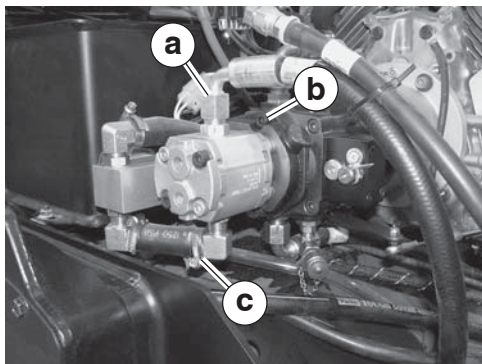

wc\_gr004183

3. Remove the two screws (b) that secure the exciter pump to the drive pump.
4. Loosen the hose clamp (c) and pull the exciter motor from the machine. Immediately plug (d) the hose.

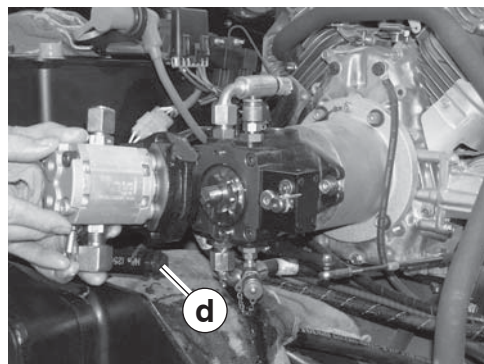
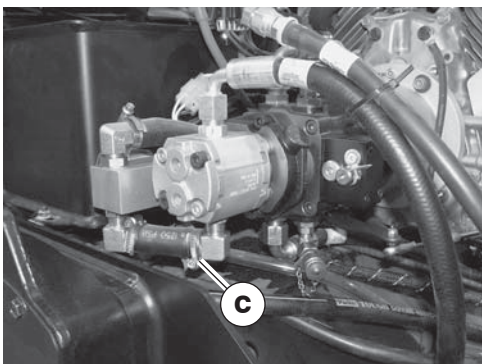

wc\_gr004184

The procedure to remove the exciter pump is now complete.



## 9.24 Installing the Exciter Pump

**Prerequisites** ■ Machine OFF and engine cool.

---

**Procedure** Follow the procedure below to install the exciter pump.

1. Place a plastic sheet and a container under the machine to collect any liquid which drains off. Dispose of this liquid in accordance with environmental protection legislation.
2. Connect the hydraulic hose to the exciter pump with the hose clamp **(c)**.

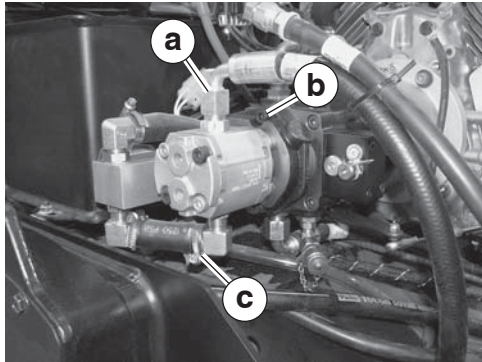

wc\_gr004183

3. Secure the exciter pump to the drive pump with two screws **(b)** .
4. Connect the outgoing hydraulic line **(a)**.
5. Check the level of the hydraulic oil; add hydraulic oil as necessary.

The procedure to install the exciter pump is now complete.

## 9.25 Removing the Drive Pump

- Prerequisites**
- Machine OFF and engine cool
  - Exciter pump removed

**Procedure** Follow the procedure below to remove the drive pump.



Burn hazard. The engine exhaust pipes are extremely hot while the engine is running and for a period of time after the engine has shut down.

- ▶ Allow the exhaust pipes to cool before performing this procedure.

1. Place a plastic sheet and a container under the machine to collect any liquid which drains off. Dispose of this liquid in accordance with environmental protection legislation.
2. Disconnect the control cable (**a**).
3. Disconnect and the plug hydraulic lines (**b** and **c**).

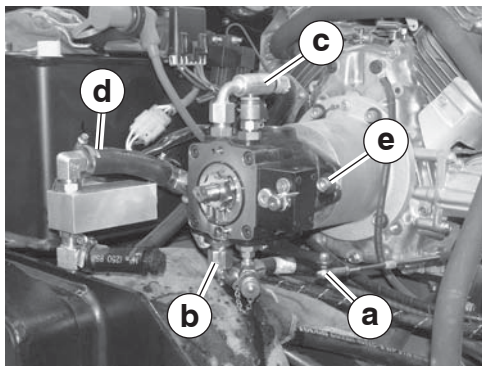

wc\_gr004186

4. Loosen the hose clamp from the hydraulic hose (**d**).
5. Remove the screws (**e**) that secure the hydraulic pump to the adapter.
6. Remove the hydraulic pump (**f**) from the adapter and immediately plug the hydraulic hose (**d**).

The procedure to remove the drive pump is now complete.

## 9.26 Installing the Drive Pump

**Prerequisites** ■ Engine and adapter installed

**Procedure** Follow the procedure below to install the drive pump.

1. Place a plastic sheet and a container under the machine to collect any liquid which drains off. Dispose of this liquid in accordance with environmental protection legislation.
2. Remove the plug from the hydraulic hose (**d**) and connect the hydraulic hose to the drive pump.

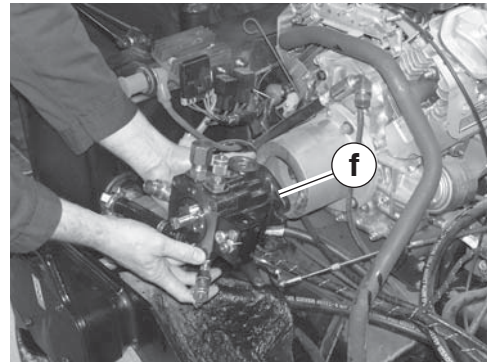
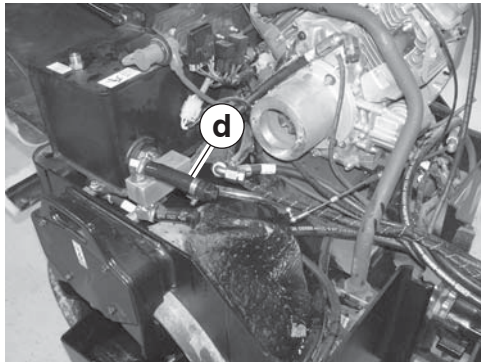

wc\_gr004187

3. Apply Loctite 243 to the screws and secure the drive pump (**f**) to the adapter. Torque the screws to 44 Nm (32 ft.lbs.).
4. Connect the hydraulic lines (**b** & **c**) to the drive pump.

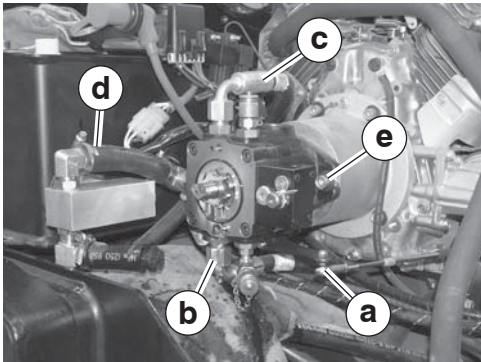

wc\_gr004186

5. Reconnect the control cable (**a**).

The procedure install the drive pump is now complete.

## 9.27 Removing the Engine

- Prerequisites**
- Crane and appropriate sling
  - Exciter pump and drive pump removed

**Procedure** Follow the procedure below to remove the engine.



Burn hazard. The engine exhaust pipes are extremely hot while the engine is running and for a period of time after the engine has shut down.

- ▶ Allow the exhaust pipes to cool before performing this procedure.

1. Disconnect the harness (a) and the wiring (b).

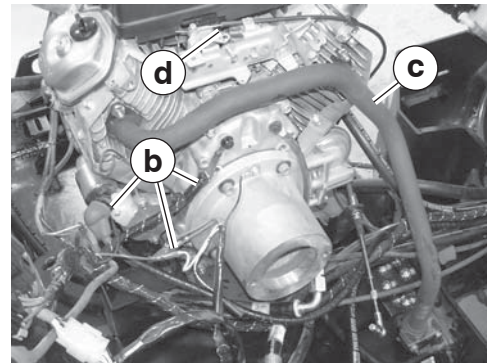
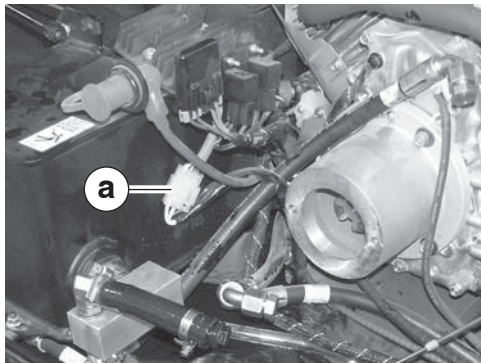

wc\_gr004173

2. Disconnect the exhaust (c) and the choke cable (d).
3. Cut the wire ties that secure the oil drain hose (e).

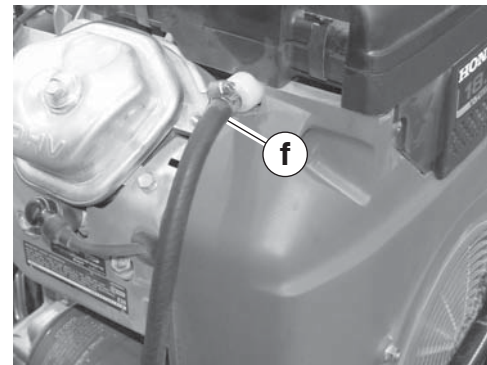
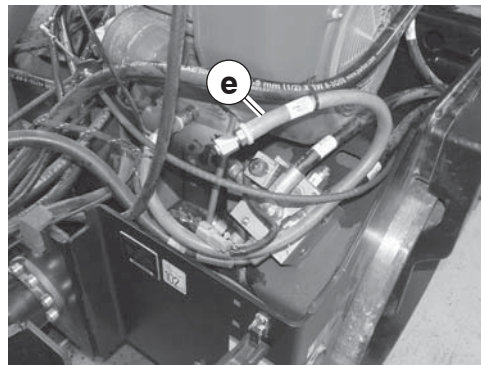

wc\_gr004174

4. Disconnect the fuel line (f).

*This procedure continues on the next page.*

*Continued from the previous page.*

5. Disconnect the lanyard (**g**) from the hydraulic tank.

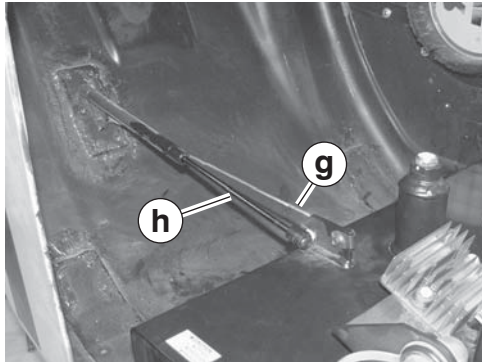

wc\_gr004177

6. Disconnect the air cylinder (**h**) from the hydraulic tank. Support the hood in the open position.
7. Disconnect and plug the exciter motor hydraulic line (**i**) from the hydraulic tank.

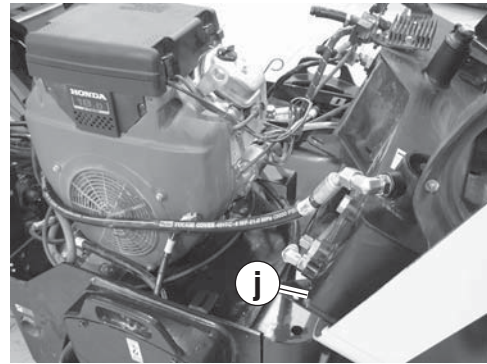
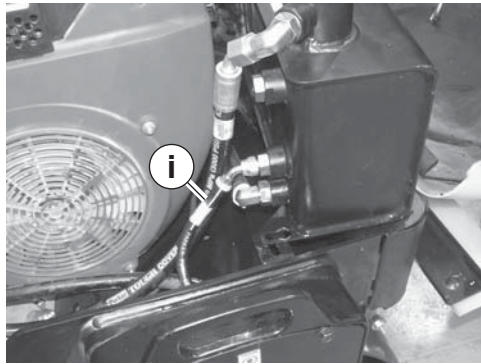

wc\_gr004175

8. Remove the screws that secure the hydraulic tank to the machine. Position the tank (**j**) so that you can access the screws that secure the engine to the frame.
9. Remove the screws that secure the engine to the frame.

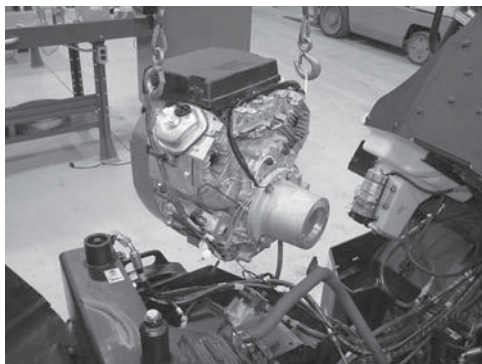

wc\_gr004176

10. Using an appropriate crane, lift the engine from the machine.

The procedure to remove the engine is now complete.



## 9.28 Installing the Engine

**Prerequisites** ■ Machine OFF and engine cool.

**Procedure** Follow the procedure below to install the engine.

1. Position the engine into the frame.

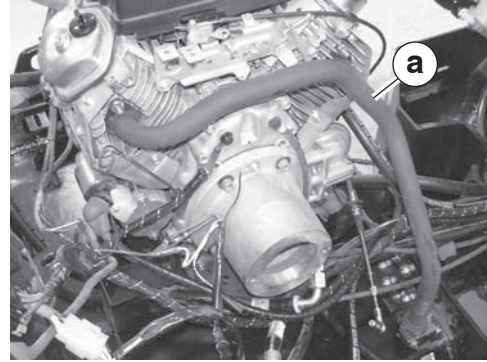
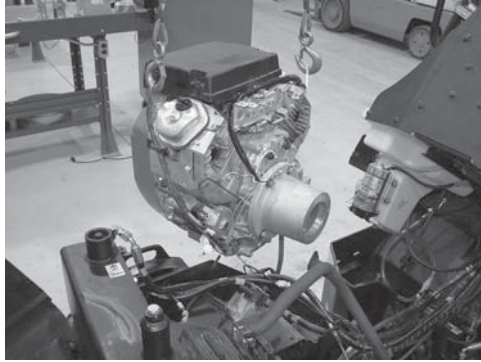

wc\_gr004178

2. Reconnect the exhaust (**a**).
3. Apply Loctite 243 to the screws and secure the engine to the frame. Torque the screws to 44 Nm (32 ft.lbs.).
4. Disconnect the harness (**b**) and the wiring (**c**).

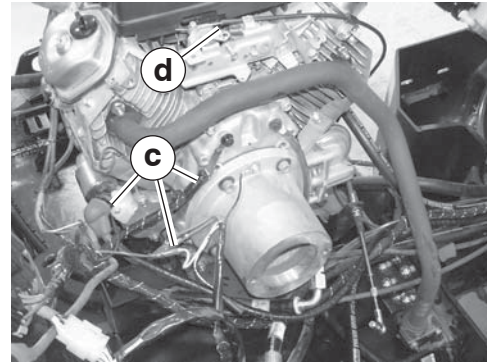
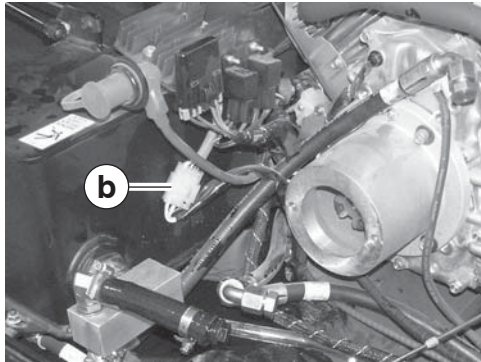

wc\_gr004179

5. Reconnect the choke cable (**d**).
6. Secure the oil drain hose (**e**) with new wire ties.

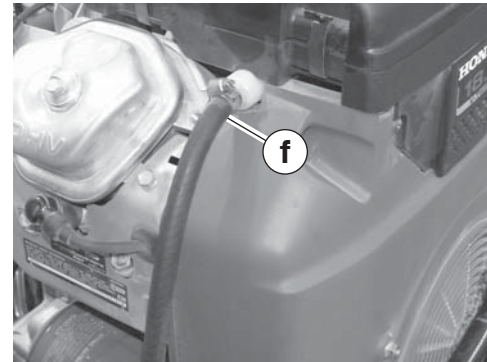
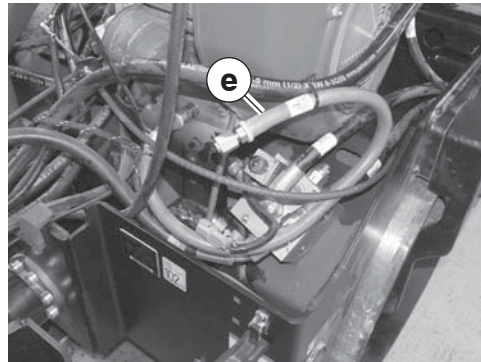

wc\_gr004174

7. Reconnect the fuel line (**f**).
- This procedure continues on the next page.*



*Continued from the previous page.*

8. Reconnect the lanyard (**g**) to the hydraulic tank.

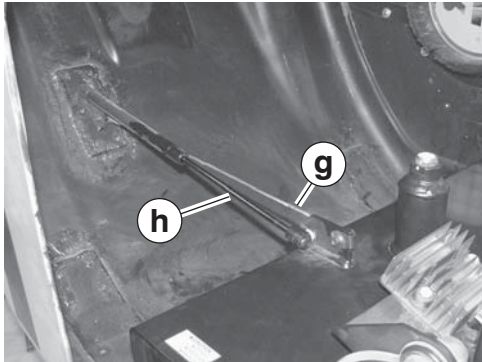

wc\_gr004177

9. Reconnect the air cylinder (**h**) to the hydraulic tank.
10. Reconnect the exciter motor hydraulic line (**i**) from the hydraulic tank.

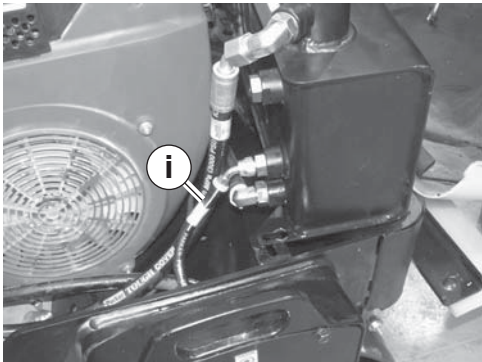

wc\_gr004180

11. Secure the hydraulic tank to the machine. Torque the nuts to 25 Nm (18 ft.lbs.).

The procedure to install the engine is now complete.

## 9.29 Removing the Steering Valve

**Prerequisites** ■ Machine OFF and engine cool.

**Procedure** Follow the procedure below to remove the steering valve.

1. Remove the front console panel (a).

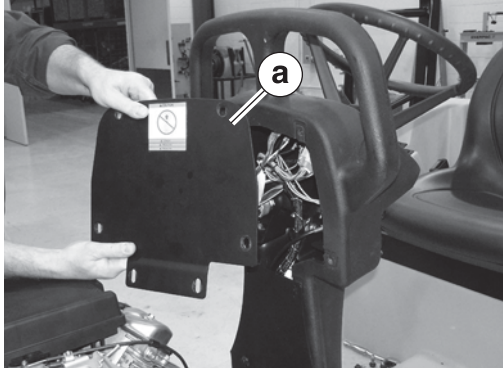

wc\_gr004201

2. Remove the cable clamp (b).
3. Remove the small cover (c) on the steering wheel.

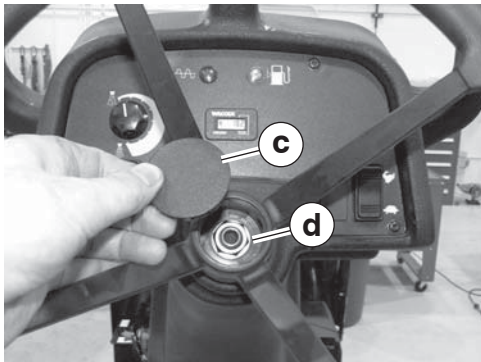

wc\_gr004202

4. Remove the nut (d) that secures the steering wheel and remove the steering wheel.
5. Remove the screws that secure the choke control (e). Allow the choke control to hang out of the way.

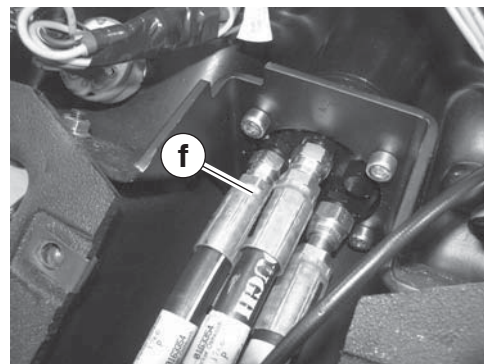
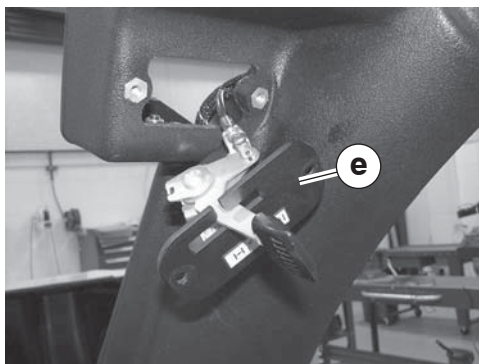

wc\_gr004203

6. Label, disconnect, and plug the hydraulic lines (f).

*This procedure continues on the next page.*

*Continued from the previous page.*

7. Remove the screws **(g)** that secure the bracket **(h)** to the console.

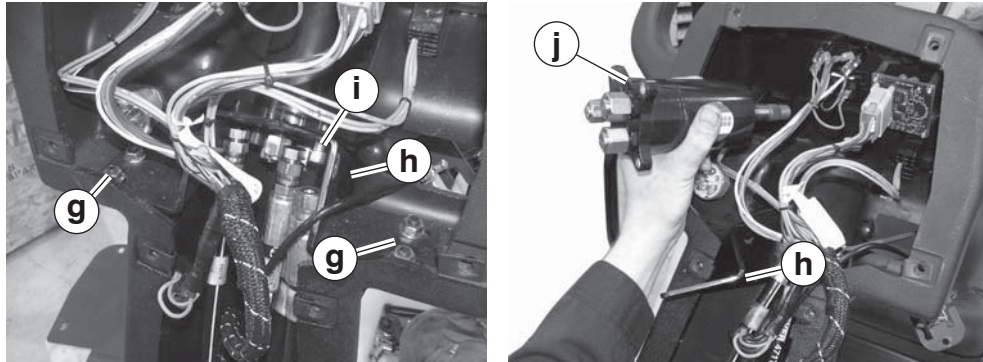

wc\_gr004203

8. Remove the screws **(i)** that secure the steering servo. Maneuver the steering valve **(j)** out of the control console.

The procedure to remove the steering valve is now complete.

## 9.30 Installing the Steering Valve

**Prerequisites** ■ Machine OFF and engine cool

**Procedure** Follow the procedure below to install the steering valve.

1. Position the steering valve (**j**) and bracket (**h**) into the control console. Secure the steering valve to the bracket with screws (**i**) .

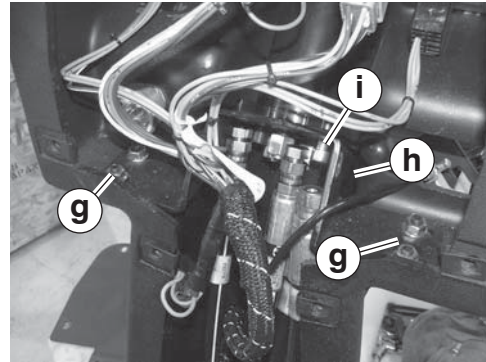
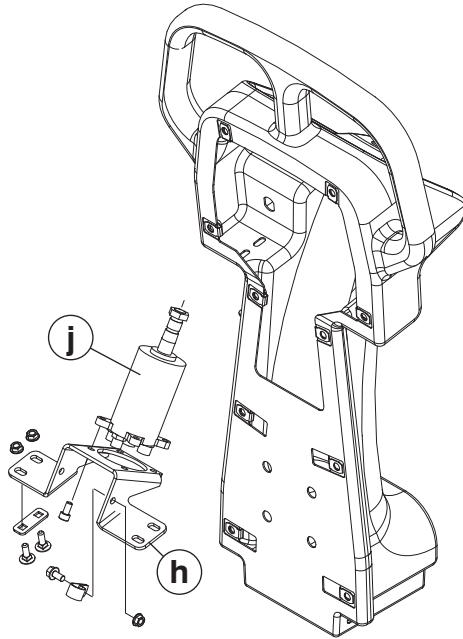

wc\_gr004240

2. Secure the bracket (**h**) to the console with the screws (**g**).
3. Connect the hydraulic lines (**f**).

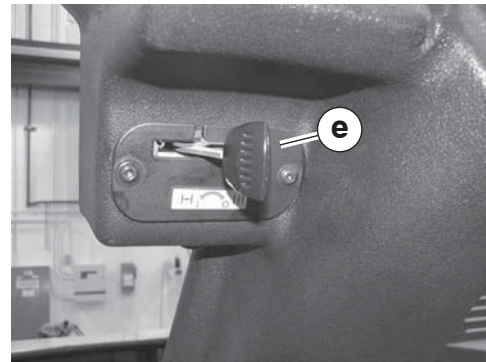
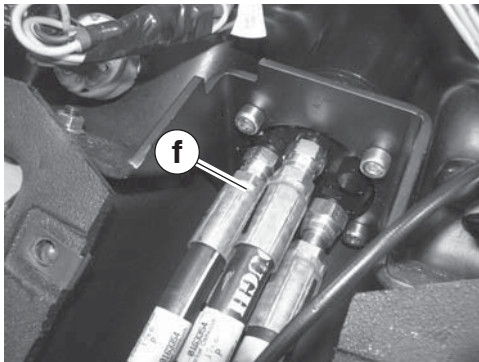

wc\_gr004241

4. Install the choke control (**e**).

*This procedure continues on the next page.*

*Continued from the previous page.*

5. Install the steering wheel and secure it with the nut (d).

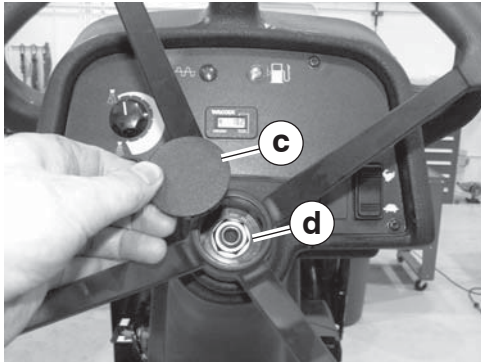

wc\_gr004202

6. Install the small cover (c) on the steering wheel.
7. Install the cable clamp (b).

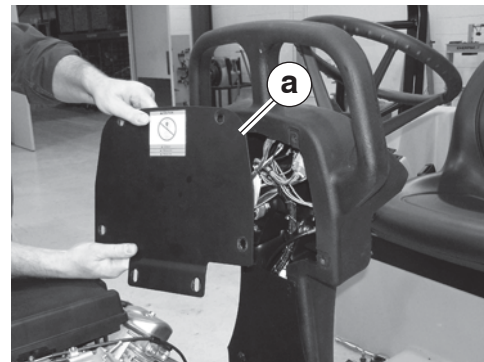
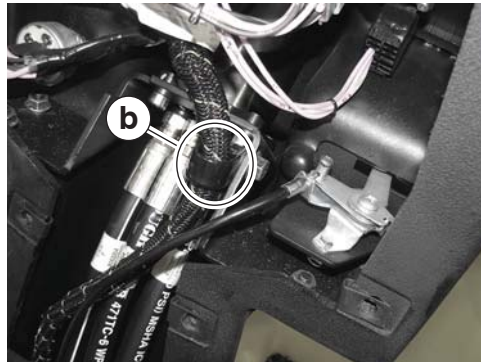

wc\_gr004242

8. Install the front console panel (a)

The procedure to install the steering valve is now complete.



## 9.31 Removing the Hydraulic Tank

**Prerequisites** ■ Engine cool

**Procedure** Follow the procedure below to remove the hydraulic tank.

1. Place a plastic sheet and a container under the machine to collect any liquid which drains off. Dispose of this liquid in accordance with environmental protection legislation.
2. Drain the hydraulic tank. See section *Changing Hydraulic Oil and Filter*.
3. Disconnect the lanyard (**g**) and the air cylinder (**h**) from the hydraulic tank. Support the hood in the open position.

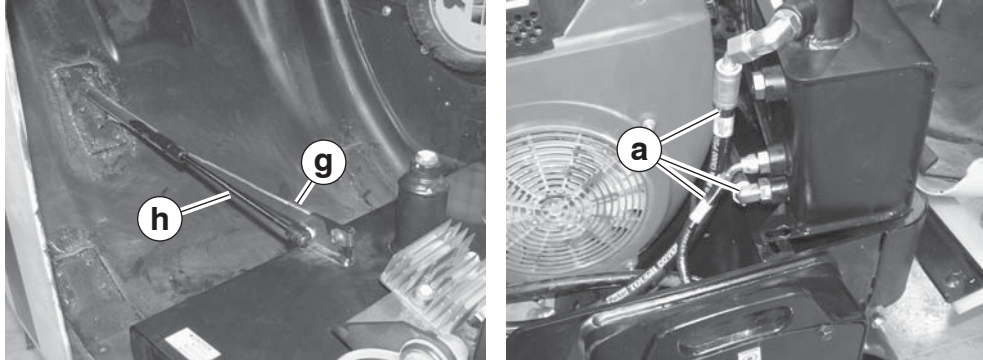

wc\_gr004205

4. Remove and cap the three hydraulic lines (**a**).
5. Remove the mounting bracket (**b**).

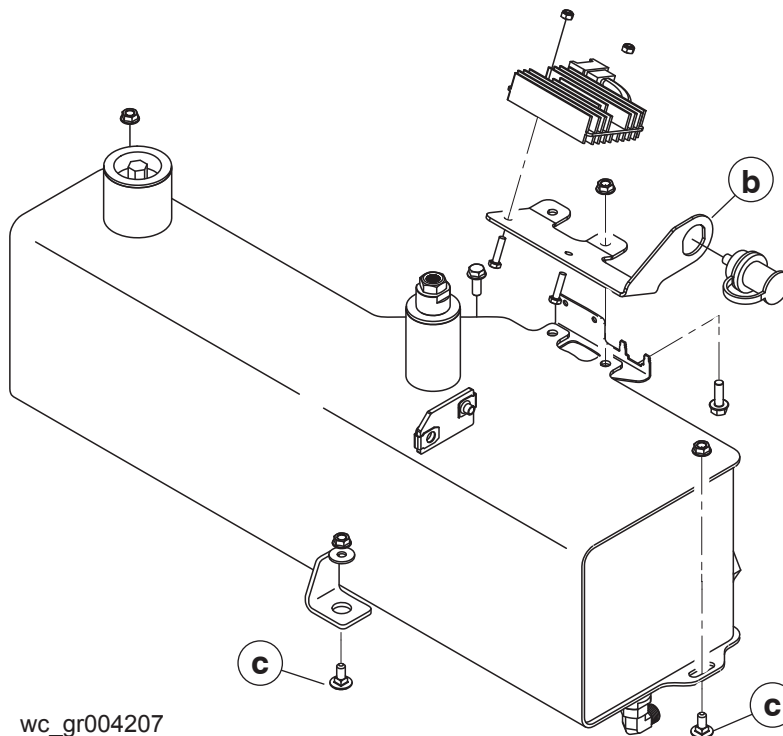

wc\_gr004207

6. Remove the screws (**c**) that secure the hydraulic tank to the frame.

*This procedure continues on the next page.*



*Continued from the previous page.*

7. Loosen the hose clamps that secure the hydraulic hoses (**d** and **e**) to the drive and exciter pumps.

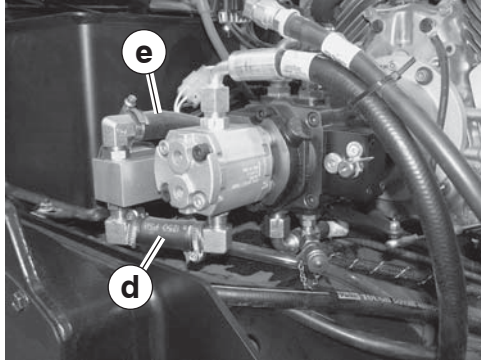

wc\_gr004206

8. Pull the hydraulic tank from the hydraulic hoses (loosen the fittings if necessary) and out of the frame.

The procedure to remove the hydraulic tank is now complete.

## 9.32 Installing the Hydraulic Tank

**Prerequisites** ■ Engine cool

**Procedure** Follow the procedure below to install the hydraulic tank.

1. Place a plastic sheet and a container under the machine to collect any liquid which drains off. Dispose of this liquid in accordance with environmental protection legislation.
2. Connect the hydraulic hoses to the hydraulic tank and position the hydraulic tank into the frame. Tighten the fittings if loosened during the removal procedure.

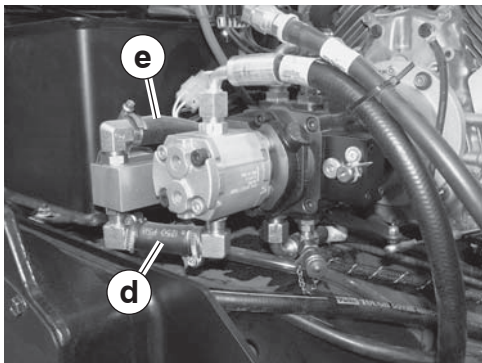

wc\_gr004206

3. Install the mounting bracket (b).

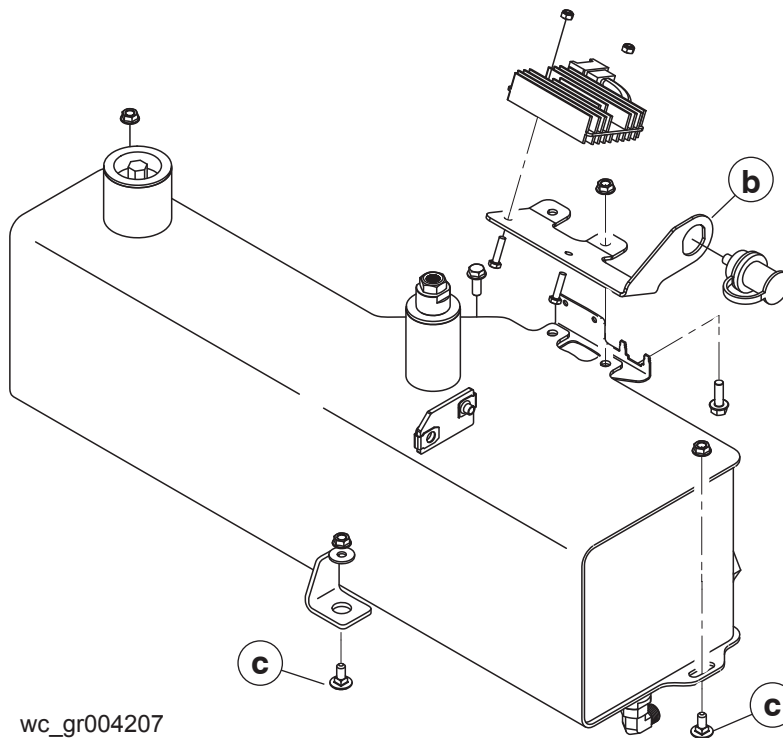

wc\_gr004207

4. Install the screws (c) that secure the hydraulic tank to the frame.

*This procedure continues on the next page.*

*Continued from the previous page.*

5. Connect the lanyard (**g**) and the air cylinder (**h**) to the hydraulic tank.

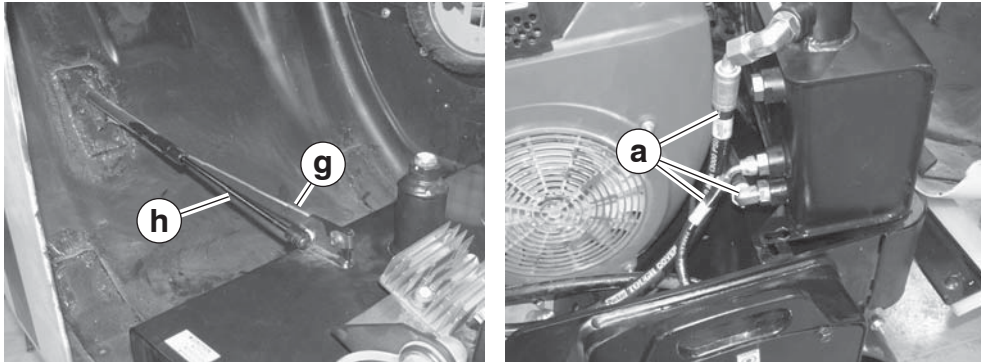

wc\_gr004205

6. Connect the three hydraulic lines (**a**).
7. Fill the hydraulic tank. See section *Changing Hydraulic Oil and Filter*.

The procedure to install the hydraulic tank is now complete.

### 9.33 Removing the Fuel Tank

- Prerequisites**
- Machine shut down
  - Platform in upright position. See section *Rear Frame Access*.
- 

**Procedure** Follow the procedure below to remove the fuel tank.

1. Drain the fuel from the fuel tank by disconnecting the fuel hose **(a)** at the engine.

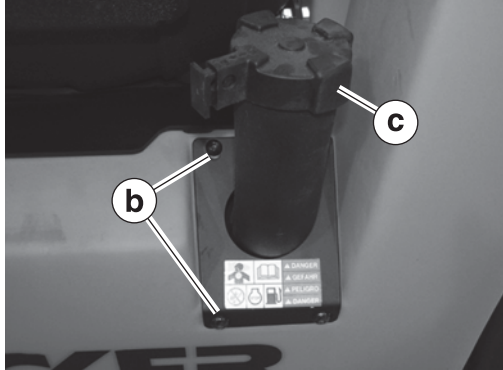

wc\_gr004230

2. Remove the screws **(b)** that secure the fuel spill guard, also remove the fuel cap **(c)**.
3. Disconnect the gas struts **(d)**.



wc\_gr004231

4. Support the platform in the open position—approximately 70°.

*This procedure continues on the next page.*

*Continued from the previous page.*

5. Disconnect the fuel sensor **(e)** from the wiring harness.

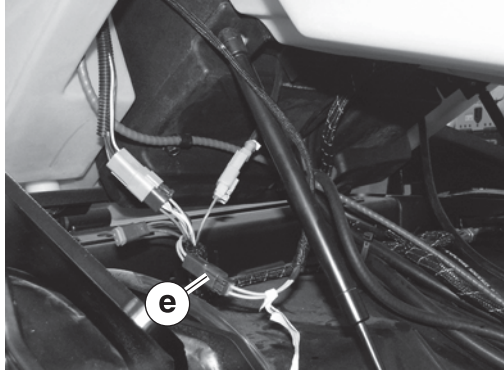

wc\_gr004243

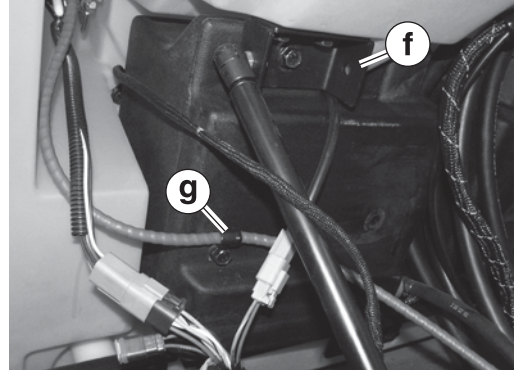

wc\_gr004232

6. Remove the gas strut brackets **(f)** from the water tank and the fuel tank. Remove the cable clip **(g)**.
7. Remove the mounting plate **(h)** from the water tank and the fuel tank, and pull the fuel tank from the platform.

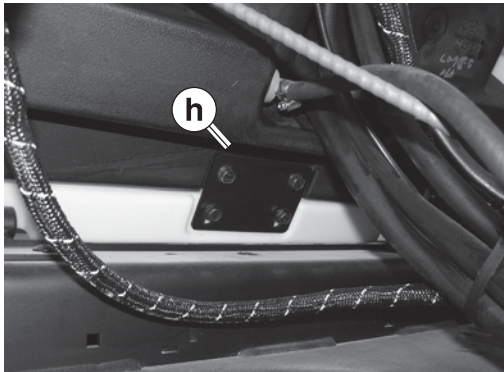

wc\_gr004233

The procedure to remove the fuel tank is now complete.

## 9.34 Installing the Fuel Tank

**Prerequisites** ■ Platform in upright position. See section *Rear Frame Access*.

**Procedure** Follow the procedure below to install the fuel tank.

1. Route the fuel level sensor wiring (i) around the control lever side of the fuel tank. Then, position the fuel tank into the water tank and secure it with the mounting plate (h). Connect the fuel level sensor to the harness.

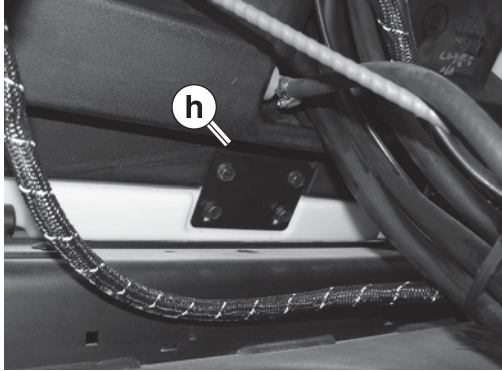

wc\_gr004233

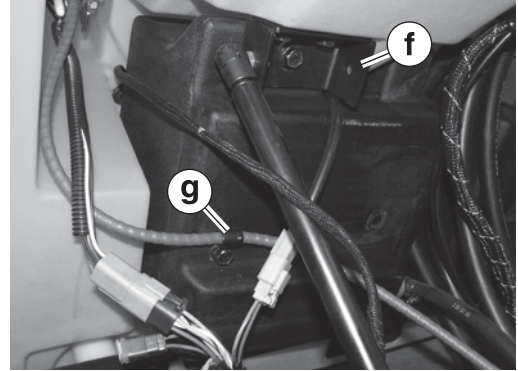

wc\_gr004232

2. Install the gas strut brackets (f) to the water tank and the fuel tank.
3. Install the cable clip (g).
4. Connect the fuel line (i) to the fuel tank.

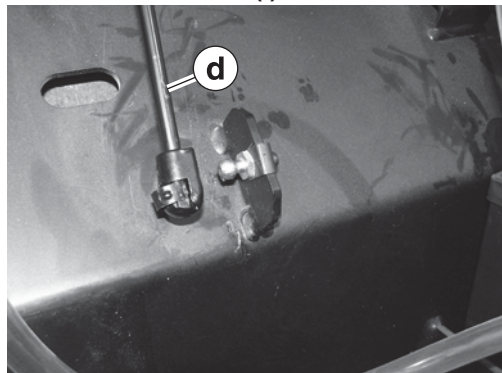

wc\_gr004238

5. Connect the gas struts (d).
6. Install the screws (b) that secure the fuel spill guard. Then, re-install the fuel cap (c).

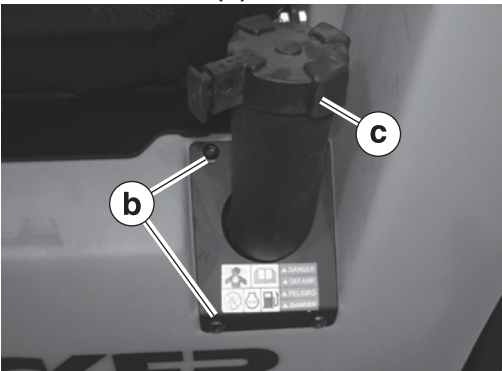

wc\_gr004239

The procedure to install the fuel tank is now complete.





10 Schematics

10.1 Hydraulic Schematic

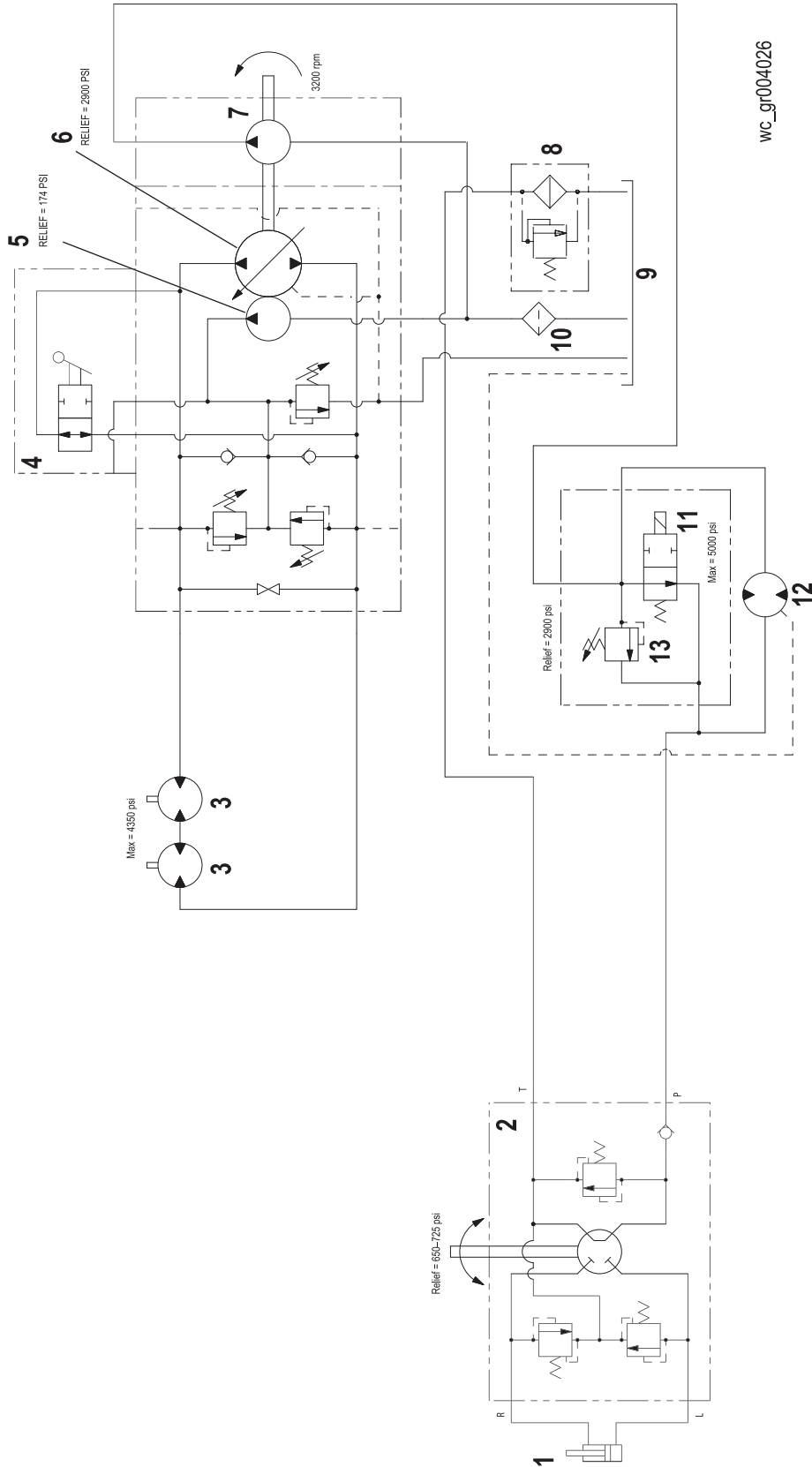

wc\_gr004026

## 10.2 Hydraulic Schematic Components

Ref.	Description	Ref.	Description
1	Steering cylinder	8	Return filter
2	Steering unit	9	Tank
3	Drive motor	10	Suction strainer
4	Bypass lever	11	Vibration solenoid valve
5	Charge pump	12	Exciter motor
6	Main pump	13	Pressure relief valve
7	Exciter pump	-	---

## 10.3 Electrical Schematic Identification—RD 12A

Use the chart below to determine which electrical schematic applies to your machine.

Roller	Item No.	Revisions	Electrical Schematic
RD 12A	0620058	111 & higher	B
		110 & lower	A
	0620320	109 & higher	B
		108 & lower	A
	0620369	111 & higher	B
		110 & lower	A

10.4 Electrical Schematic “A”—RD 12A

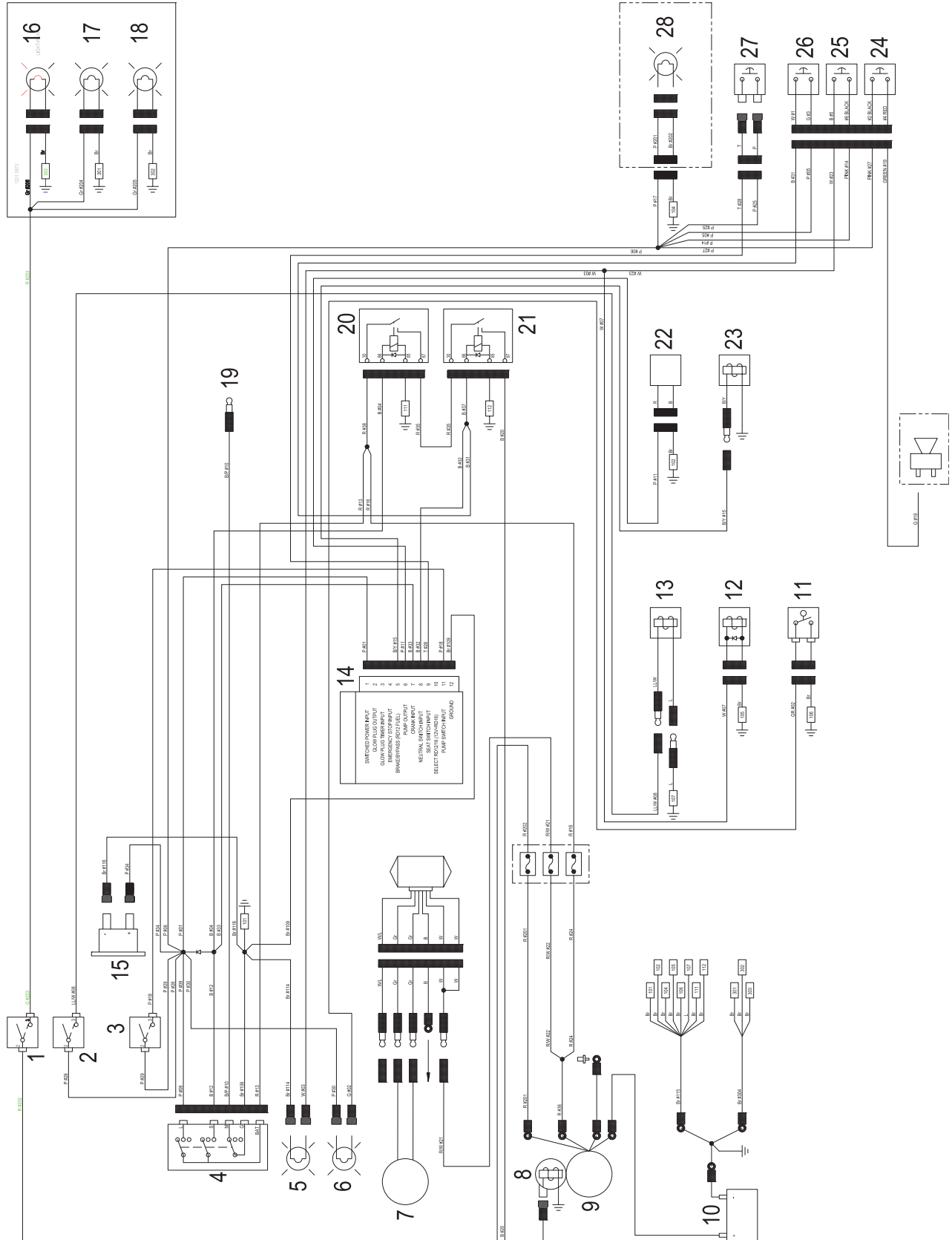

## 10.5 Electrical Schematic "A" Components—RD 12A

Ref.	Description	Ref.	Description
1	Work light switch	16	Rear light (optional)
2	Throttle switch	17	Left head light (optional)
3	Pump switch	18	Right head light (optional)
4	Key switch	19	To magneto kill
5	Vibration indicator light (green)	20	Crank relay
6	Low fuel indicator light (amber)	21	Neutral relay
7	Alternator (30A)	22	Spray bar pump
8	Starter solenoid	23	Fuel cutoff solenoid
9	Starter motor	24	Reverse switch
10	Battery	25	Vibration switch
11	Fuel level sensor	26	Neutral switch
12	Vibration solenoid (front)	27	Seat switch
13	Throttle solenoid	28	Strobe light (optional)
14	Pump timer module	29	Backup alarm (optional)
15	Hourmeter	-	---

Wire Colors							
B	Black	R	Red	Y	Yellow	Or	Orange
G	Green	T	Tan	Br	Brown	Pr	Purple
L	Blue	V	Violet	Cl	Clear	Sh	Shield
P	Pink	W	White	Gr	Gray	LL	Light blue

10.6 Electrical Schematic “B”—RD 12A

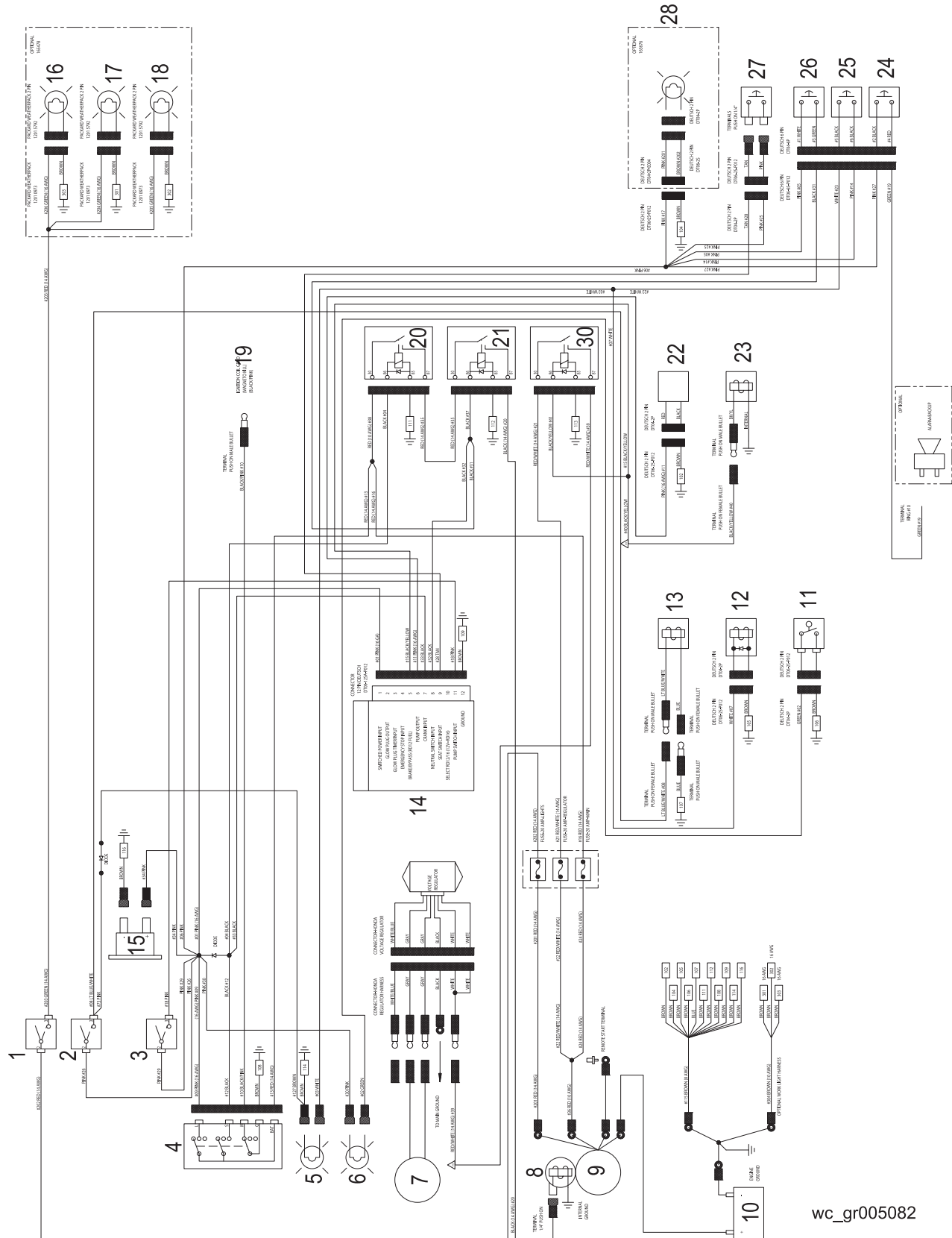

wc\_gr005082



## 10.7 Electrical Schematic "B" Components—RD 12A

Ref.	Description	Ref.	Description
1	Work light switch	16	Rear light (optional)
2	Throttle switch	17	Left head light (optional)
3	Pump switch	18	Right head light (optional)
4	Key switch	19	To magneto kill
5	Vibration indicator light (green)	20	Crank relay
6	Low fuel indicator light (amber)	21	Neutral relay
7	Alternator (30A)	22	Spray bar pump
8	Starter solenoid	23	Fuel cutoff solenoid
9	Starter motor	24	Reverse switch
10	Battery	25	Vibration switch
11	Fuel level sensor	26	Neutral switch
12	Vibration solenoid (front)	27	Seat switch
13	Throttle solenoid	28	Strobe light (optional)
14	Pump timer module	29	Backup alarm (optional)
15	Hourmeter	30	Voltage regulator relay

Wire Colors							
B	Black	R	Red	Y	Yellow	Or	Orange
G	Green	T	Tan	Br	Brown	Pr	Purple
L	Blue	V	Violet	Cl	Clear	Sh	Shield
P	Pink	W	White	Gr	Gray	LL	Light blue

10.8 Electrical Schematic—RD 12

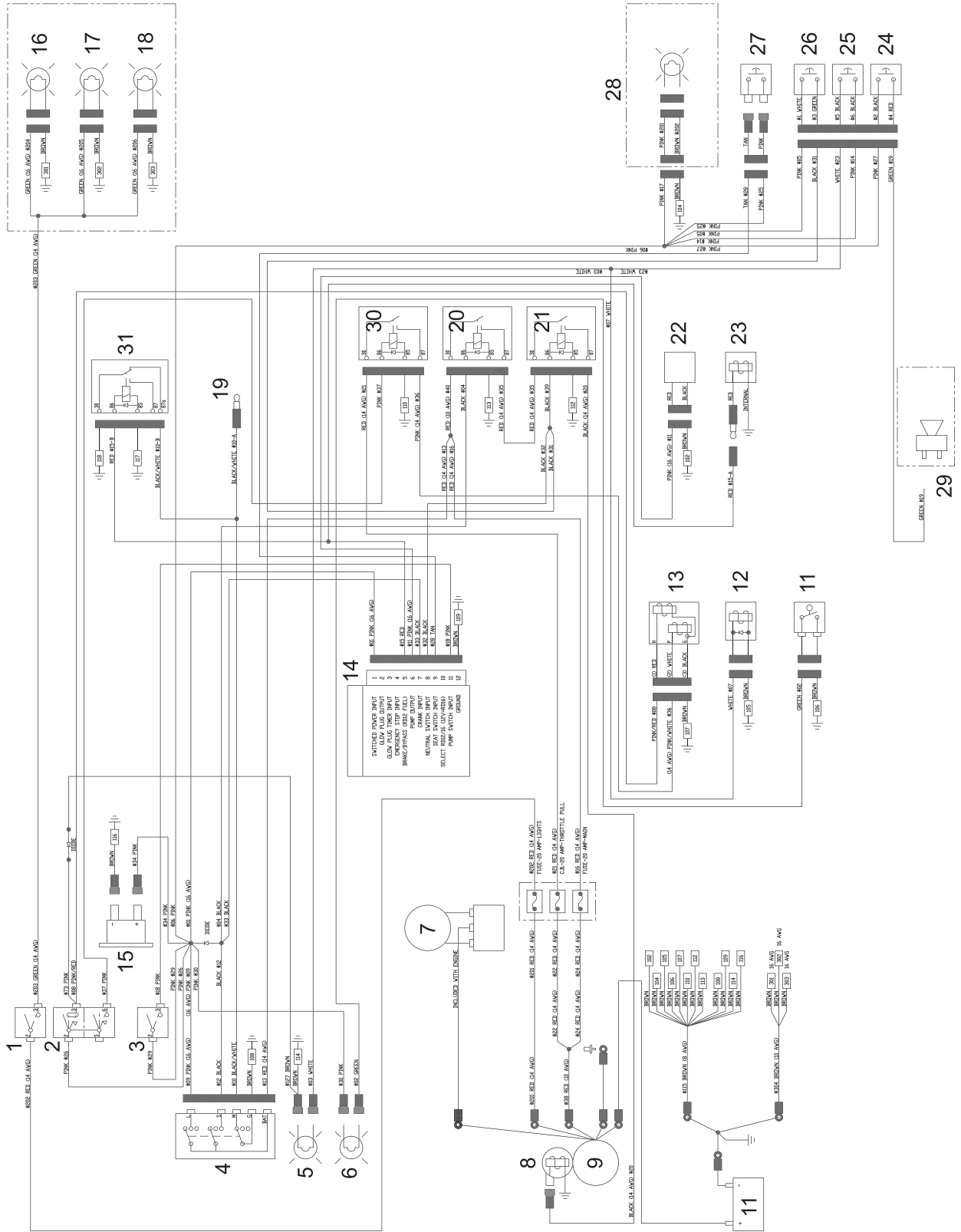

wc\_gr005888

## 10.9 Electrical Schematic Components—RD 12

Ref.	Description	Ref.	Description
1	Work light switch	17	Left head light (optional)
2	Throttle switch	18	Right head light (optional)
3	Pump switch	19	To magneto kill
4	Key switch	20	Crank relay
5	Vibration indicator light (green)	21	Neutral relay
6	Low fuel indicator light (amber)	22	Spray bar pump
7	Alternator (30A)	23	Fuel cutoff solenoid
8	Starter solenoid	24	Reverse switch
9	Starter motor	25	Vibration switch
10	Battery	26	Neutral switch
11	Fuel level sensor	27	Seat switch
12	Vibration solenoid (front)	28	Strobe light (optional)
13	Throttle solenoid	29	Backup alarm (optional)
14	Pump timer module	30	Throttle relay
15	Hourmeter	31	Quick shut-off relay
16	Rear light (optional)	—	—

Wire Colors							
B	Black	R	Red	Y	Yellow	Or	Orange
G	Green	T	Tan	Br	Brown	Pr	Purple
L	Blue	V	Violet	Cl	Clear	Sh	Shield
P	Pink	W	White	Gr	Gray	LL	Light blue

11 Technical Data

11.1 Engine

Engine Power Rating

RD 12A:

Net power rating per SAE J1349. Actual power output may vary due to conditions of specific use.

RD 12:

Gross power rating per SAE J1995. Actual power output may vary due to conditions of specific use.

Item no.		RD 12A	RD 12
<b>Engine</b>			
Engine type		4-stroke, 2 cylinder, air cooled	
Engine make		Honda	Wacker Neuson
Engine model		GX 610	WM 650
Max. rated power @ rated speed	kW (hp)	13.4 (18.0) @ 3600 rpm	15.3 (20.5) @ 3600 rpm
Displacement	cm <sup>3</sup> (in <sup>3</sup> )	614 (37.5)	653 (39.9)
Spark plug		(NGK) BPR6ES / (NGK) BPR6ES high heat	NGK-BP6ES
Electrode gap	mm (in.)	0.71-0.79 (0.028-0.031)	0.6-0.7 (0.024-0.027)
Engine speed - operating	rpm	3100	
Engine speed - idle	rpm	2000	
Valve clearance (cold)		0.10-0.16 (0.004-0.006)	0.08-0.115 (0.0031-0.0045)
intake:	mm		
exhaust:	(in.)	0.10-0.16 (0.004-0.006)	0.08-0.115 (0.0031-0.0045)
Battery	V	12VDC	
Air cleaner	type	Dual element	
Fuel	type	Regular unleaded gasoline	
Fuel tank capacity	L (gal)	23 (6.1)	
Fuel consumption	L (gal)/hr	4.9 (1.3)	6.0 (1.35)
Engine oil	type L (qt)	10W30 SG, SF/CC, CD 1.2 (1.3)	
Coolant capacity	L (gal)	--	--

## 11.2 Roller

Item No.		RD 12A	RD 12
<b>Roller</b>			
Dry Weight	kg (lb.)	1002 (2171)	
Curb Clearance: Right Left	mm (in.)	400 (15.7) 208 (8.2)	
Water Tank Capacity	l (gal.)	100 (26.4)	
Outside Turning Radius	m (ft.)	2.44 (8.0)	
Forward / Reverse Speed	km/hr. (mph)	0-8.7 (0-5.4)	
Gradeability		30%	
Vibration Frequency	vpm	4200	

## 11.3 Lubrication

Item No.		RD 12A	RD 12
<b>Lubrication</b>			
Engine Lubrication	type l (pt.)	SAE 10W30 Class SG, SF, or SE rated 1.6 (3.5)	
Hydraulic System	type l (gal.)	Premium grade, anti-wear hydraulic fluid 10W30 21.6 (5.7)	
Exciter	type	Mobil XHP222	
Rear Drum Drive Bearing	type qty.	Mobil XHP222 2-3 shots with hand-held grease gun	
Articulated Joint	type qty.	Mobil XHP222 2-3 shots with hand-held grease gun	

11.4 Dimensions

mm (in.)

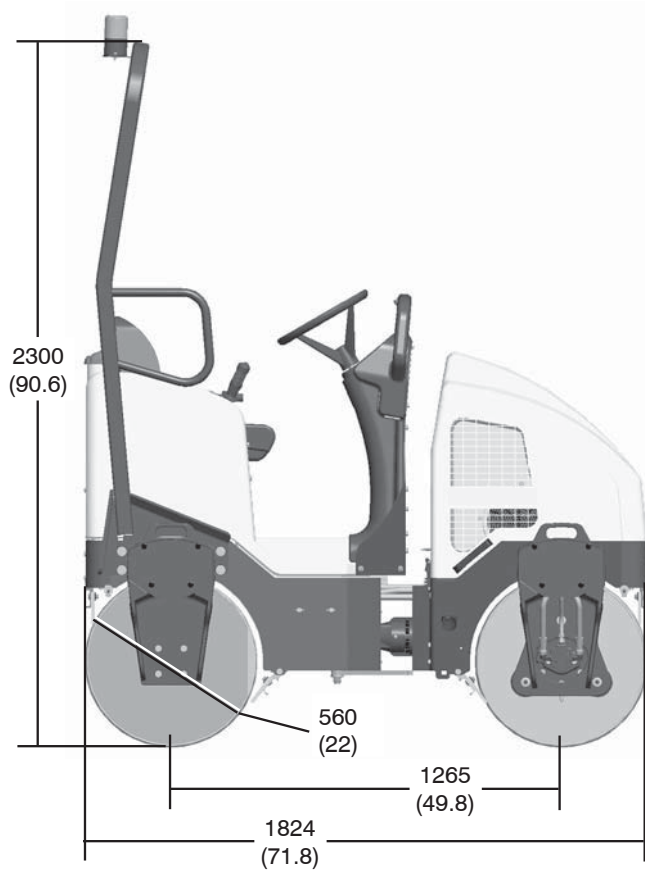

wc\_gr005905



## 11.5 Sound Measurements

The operating sound level, measured per the requirements of Appendix 1, Paragraph 1.7.4.f of the EC-Machine Regulations, is:

- the guaranteed sound power level ( $L_{WA}$ ):  
RD 12 = 102 dB(A)
- the sound pressure level at operator's location ( $L_{pA}$ ):  
RD 12 = 85.6 dB(A)

This sound value was determined according to ISO 3744 for the sound power level ( $L_{WA}$ ).

## 11.6 Measurements of Operator Exposure to Vibration

The operator of this machine should expect to be exposed to vibration levels listed below when using the machine in performance of its normally intended function:

- Maximum hand/arm vibration levels are:

$$\text{RD 12} = 1.4 \text{ m/s}^2 \text{ (4.6 ft/s}^2\text{)}$$

These are the representative values of the weighted root mean square (**rms**) acceleration to which the hands and arms are subjected. These weighted **rms** values are measured according to ISO 5349-1.

- Whole body vibration levels do not exceed:

$$\text{RD 12} = 0.22 \text{ m/s}^2 \text{ (0.7 ft/s}^2\text{)}$$

These are the representative values of the weighted root mean square (**rms**) acceleration to which the whole body is subjected. These weighted **rms** values are measured according to ISO 2631-1.

The results are compliant to the limit and action vibration values (hand/arm and whole body) as specified in European directive 2002/44/EC.

**11.7 Hydraulic Pressures**

System	Operating Pressure		Relief Pressure	
	bar	psi	bar	psi
Drive**	55–69	800–1000	200	2900
Steering* —while turning	0–41	0–725	45–51	650–725
Vibration —single drum	55–76	800–1100	200	2900

\* Values for hard-packed surface shown. Values may differ depending on surface.

\*\* Charge pressure: 11.4 – 12.8 bar (165–185 psi).

## Threadlockers and Sealants

### Threadlockers and Sealants

Threadlocking adhesives and sealants are specified throughout this manual by a notation of “S” plus a number (S#) and should be used where indicated. Threadlocking compounds normally break down at temperatures above 175°C (350°F). If a screw or bolt is hard to remove, heat it using a small propane torch to break down the sealant. When applying sealants, follow instructions on container. The sealants listed are recommended for use on Wacker Neuson equipment.

<b>TYPE</b> ( ) = Europe	<b>COLOR</b>	<b>USAGE</b>	<b>PART NO. – SIZE</b>
Loctite 222 Hernon 420 Omnifit 1150 (50M)	Purple	Low strength, for locking threads smaller than 6 mm (1/4”). Hand tool removable. Temp. range: -54 to 149°C (-65 to 300°F)	73287 - 10 ml
Loctite 243 Hernon 423 Omnifit 1350 (100M)	Blue	Medium strength, for locking threads larger than 6 mm (1/4”). Hand tool removable. Temp. range: -54 to 149°C (-65 to 300°F)	29311 - .5 ml 17380 - 50 ml
Loctite 271/277 Hernon 427 Omnifit 1550 (220M)	Red	High strength, for all threads up to 25 mm (1”). Heat parts before disassembly. Temp. range: -54 to 149°C (-65 to 300°F)	29312 - .5 ml 26685 - 10 ml 73285 - 50 ml
Loctite 290 Hernon 431 Omnifit 1710 (230LL)	Green	Medium to high strength, for locking preassembled threads and for sealing weld porosity (wicking). Gaps up to 0.13 mm (0.005”) Temp. range: -54 to 149°C (-65 to 300°F)	28824 - .5 ml 25316 - 10 ml
Loctite 609 Hernon 822 Omnifit 1730 (230L)	Green	Medium strength retaining compound for slip or press fit of shafts, bearings, gears, pulleys, etc. Gaps up to 0.13 mm (0.005”) Temp. range: -54 to 149°C (-65 to 300°F)	29314 - .5 ml
Loctite 545 Hernon 947 Omnifit 1150 (50M)	Brown	Hydraulic sealant Temp. range: -54 to 149°C (-65 to 300°F)	79356 - 50 ml
Loctite 592 Hernon 920 Omnifit 790	White	Pipe sealant with Teflon for moderate pressures. Temp. range: -54 to 149°C (-65 to 300°F)	26695 - 6 ml 73289 - 50 ml
Loctite 515 Hernon 910 Omnifit 10	Purple	Form-in-place gasket for flexible joints. Fills gaps up to 1.3 mm (0.05”) Temp. range: -54 to 149°C (-65 to 300°F)	70735 - 50 ml

## Threadlockers and Sealants



### Threadlockers and Sealants (continued)

Threadlocking adhesives and sealants are specified throughout this manual by a notation of “S” plus a number (S#) and should be used where indicated. Threadlocking compounds normally break down at temperatures above 175°C (350°F). If a screw or bolt is hard to remove, heat it using a small propane torch to break down the sealant. When applying sealants, follow instructions on container. The sealants listed are recommended for use on Wacker Neuson equipment.

<b>TYPE</b> ( ) = Europe	<b>COLOR</b>	<b>USAGE</b>	<b>PART NO. – SIZE</b>
Loctite 496 Heron 110 Omnifit Sicomet 7000	Clear	Instant adhesive for bonding rubber, metal and plastics; general purpose. For gaps up to 0.15 mm (0.006”) Read caution instructions before using. Temp. range: -54 to 82°C (-65 to 180°F)	52676 - 1oz.
Loctite Primer T Heron Primer 10 Omnifit VC Activator	Aerosol Spray	Fast curing primer for threadlocking, retaining and sealing compounds. Must be used with stainless steel hardware. Recommended for use with gasket sealants.	2006124-6 oz.

## Torque Values

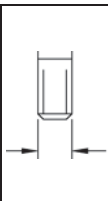
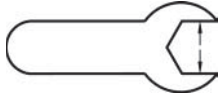
### Metric Fasteners (DIN)

	TORQUE VALUES (Based on Bolt Size and Hardness)						WRENCH SIZE			
	8.8		10.9		12.9					
Size	Nm	ft.lb.	Nm	ft.lb.	Nm	ft.lb.	Metric	Inch	Metric	Inch
M3	1.2	*11	1.6	*14	2.1	*19	5.5	7/32	2.5	–
M4	2.9	*26	4.1	*36	4.9	*43	7	9/32	3	–
M5	6.0	*53	8.5	6	10	7	8	5/16	4	–
M6	10	7	14	10	17	13	10	–	5	–
M8	25	18	35	26	41	30	13	1/2	6	–
M10	49	36	69	51	83	61	17	11/16	8	–
M12	86	63	120	88	145	107	19	3/4	10	–
M14	135	99	190	140	230	169	22	7/8	12	–
M16	210	155	295	217	355	262	24	15/16	14	–
M18	290	214	405	298	485	357	27	1-1/16	14	–
M20	410	302	580	427	690	508	30	1-1/4	17	–

1 ft.lb. = 1.357 Nm

\* = in.lb.

1 inch = 25.4 mm

# Torque Values

## Torque Values (continued)

### Inch Fasteners (SAE)

Size	SAE 5		SAE 8		SAE 9		SAE 10		SAE 12	
	Nm	ft.lb.	Nm	ft.lb.	Nm	ft.lb.	Metric	Inch	Metric	Inch
No.4	0.7	*6	1.0	*14	1.4	*12	5.5	1/4	–	3/32
No.6	1.4	*12	1.9	*17	2.4	*21	8	5/16	–	7/64
No.8	2.5	*22	3.5	*31	4.7	*42	9	11/32	–	9/64
No.10	3.6	*32	5.1	*45	6.8	*60	–	3/8	–	5/32
1/4	8.1	6	12	9	16	12	–	7/16	–	3/32
5/16	18	13	26	19	33	24	13	1/2	–	1/4
3/8	31	23	45	33	58	43	–	9/16	–	5/16
7/16	50	37	71	52	94	69	16	5/8	–	3/8
1/2	77	57	109	80	142	105	19	3/4	–	3/8
9/16	111	82	156	115	214	158	–	13/16	–	–
5/8	152	112	216	159	265	195	24	15/16	–	1/2
3/4	271	200	383	282	479	353	–	1-1/8	–	5/8

1 ft.lb. = 1.357 Nm

\* = in.lb.

1 inch = 25.4 mm





